

ASSEMBLY INSTRUCTIONS HUTCH

HARDWARE

Screw 3/4"(20mm.) (2pcs.)
(Attached)

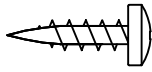

Screw Driver (Not Included)

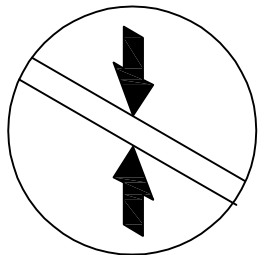
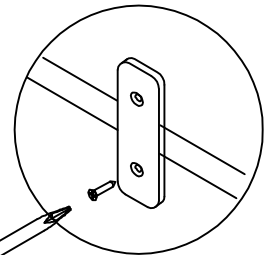
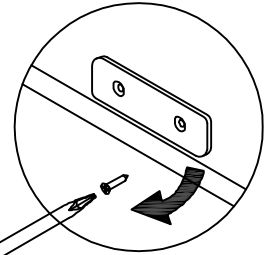
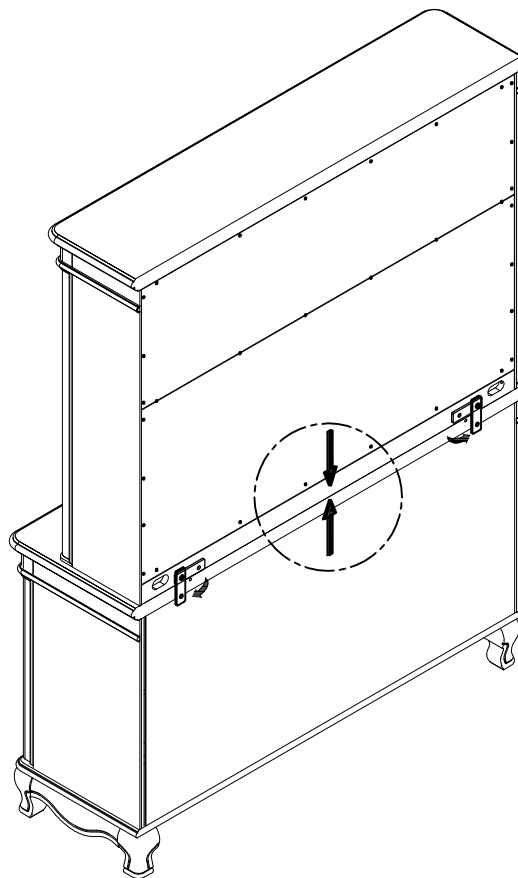
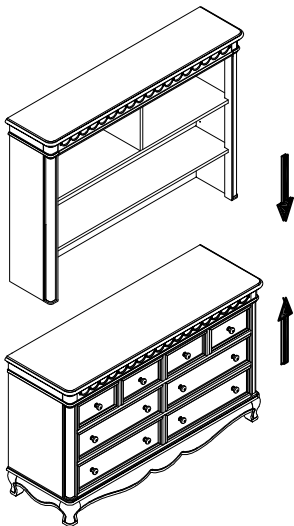
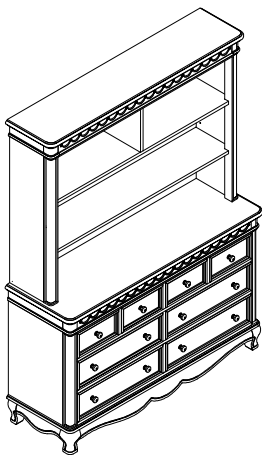
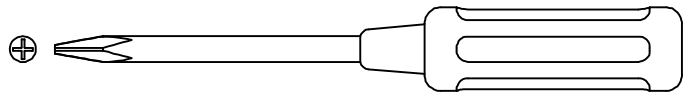

B. Metal plate already attached at HUTCH behind.
Pull out 1 screw at each metal plate, take around to
bottom side, attached again screw & back plate to
DRESSER.

RED ARROW STICKER
(ALREADY ATTACHED)

A. Put the hutch to the top of
case good (example :
dresser) in back side.



NOTE : YOU CAN APPLY YOUR HUTCH WITH "COMBO"
OR "DRESSER."

**"THE PRODUCT IMAGES SHOWN ARE FOR ILLUSTRATION PURPOSES
ONLY AND MAY NOT BE AN EXACT REPRESENTATION OF THE PRODUCT."**

INSTRUCTIONS D'ASSEMBLAGE

CRÉDENCE

MATÉRIEL

Vis De 3/4" (20 mm) (2 pcs)
(Attachés)

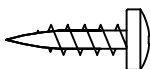

Tour nevis (Non Inclus)

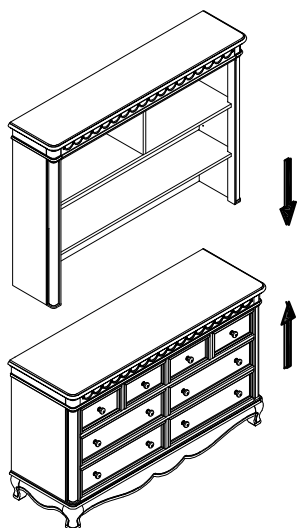
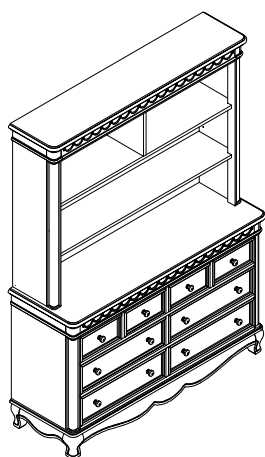
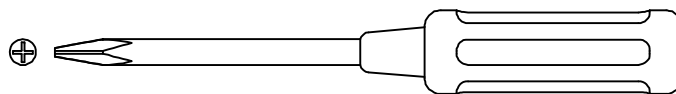

A. Mettre la cage au début de marchandises cas (par exemple : buffet) en arrière.

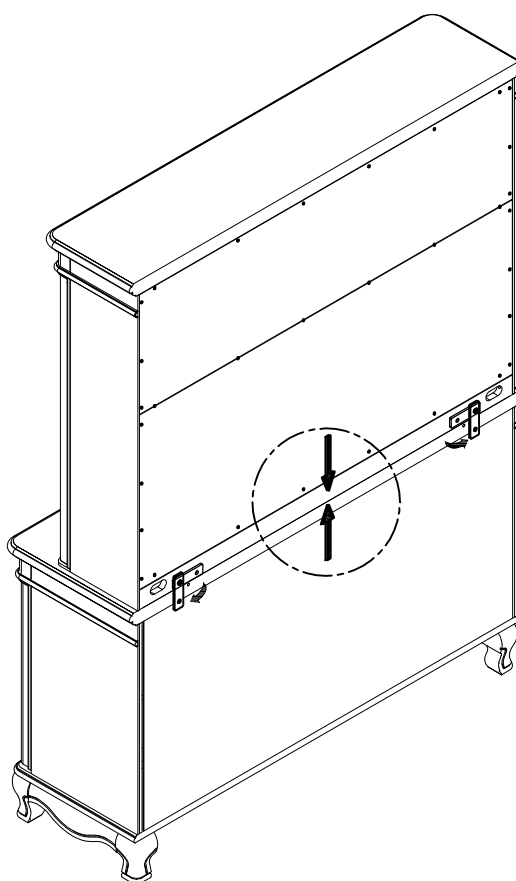

B. Plaque de métal déjà fixée au clapier derrière. Retirer une vis à chaque plaque de métal, prendre environ bas sur le côté, joint à nouveau la vis et la plaque arrière à la buffet.

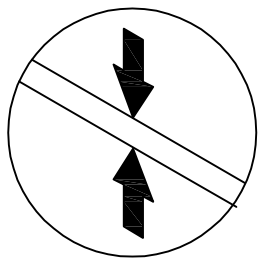
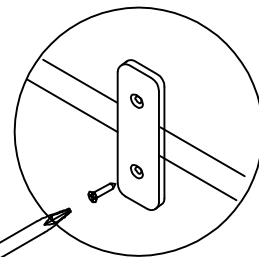
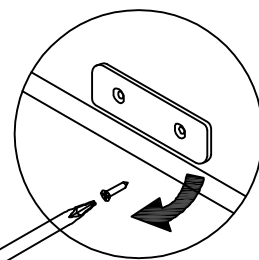

VIGNETTE FLÈCHE ROUGE
(DÉJA FIXÉE)



NOTE : VOUS POUVEZ APPLIQUER VOTRE CRÉDENCE
AVEC "COMBO" ou "DRESSER".

**"LES IMAGES DU PRODUIT PRÉSENTÉES SONT UNIQUEMENT À TITRE
D'ILLUSTRATION ET PEUVENT NE PAS ÊTRE UNE REPRÉSENTATION
EXACTE DU PRODUIT. "**