

ASSEMBLY INSTRUCTIONS

Conversion Kit

GLENDALE

Model # 23570

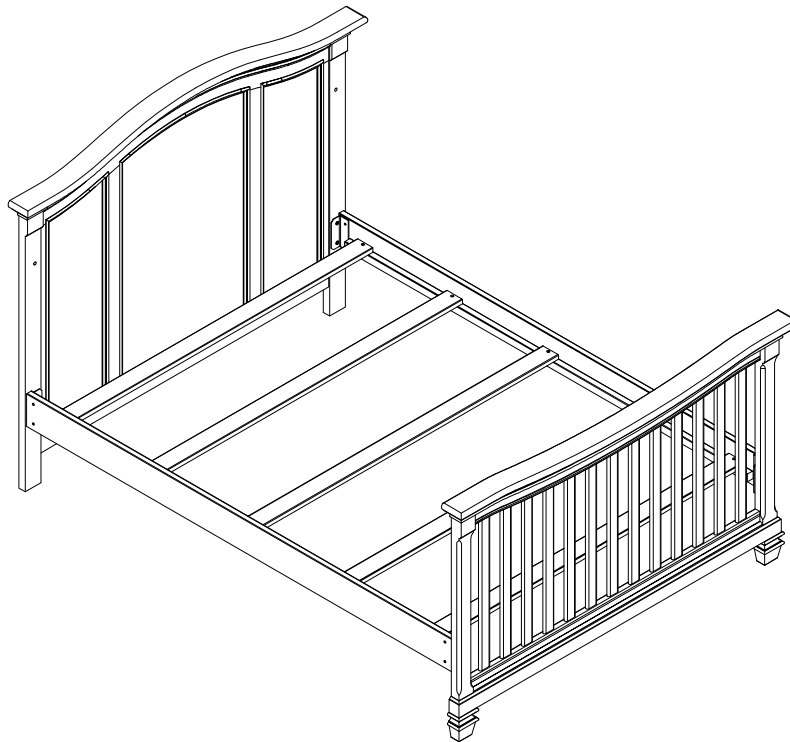

"THE PRODUCT IMAGES SHOWN ARE FOR ILLUSTRATION PURPOSES ONLY AND MAY NOT BE AN EXACT REPRESENTATION OF THE PRODUCT."

"RECOMMENDATION: We recommend the use of a Bunkie Board or box spring under a mattress for this conversion kit."

Carefully remove and lay out all parts. Familiarize yourself with all exhibits and diagrams to facilitate the assembly of your crib

TOOLS REQUIRED :

Allenkey (supplied)

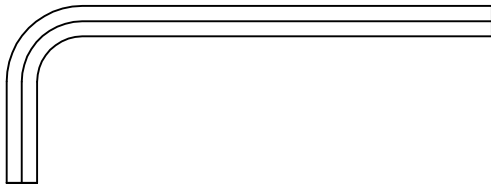

Screw Driver (Unsupplied)

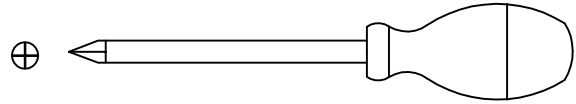

PART ENCLOSED IN CARTON

A. Rails (2 pcs)



B. Slat (5 pcs)

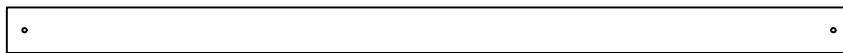

HARDWARE

C. Allenbolt 1" (25 mm) (4 pcs)



L. Nut 3/4" (20 mm) (6 pcs)

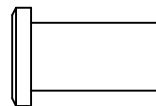

D. Allenbolt 3/4" (20 mm) (6 pcs)

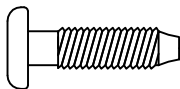

W. Spring Washer (8 pcs)

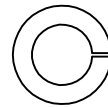

G. Screw 1 1/4" (30 mm) (10 pcs)

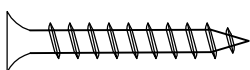

N. Allenkey (2 pcs) (length may vary)



Make sure the bolts are tightly locked against the washers during assembly.
 (Please add an extra 1/2 revolution to all the bolts when using spring washer after tightening)

STEP 1 " ASSEMBLY OF HEAD BOARD "

THIS STEP REQUIRES :

Headboard (1 pc)

A. Rails (2 pcs)

N. Allenkey (2 pcs)

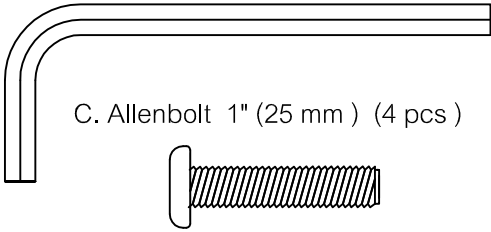

C. Allenbolt 1" (25 mm) (4 pcs)

W. Spring Washer (4 pcs)

L. Nut 3/4" (20 mm) (4 pcs)

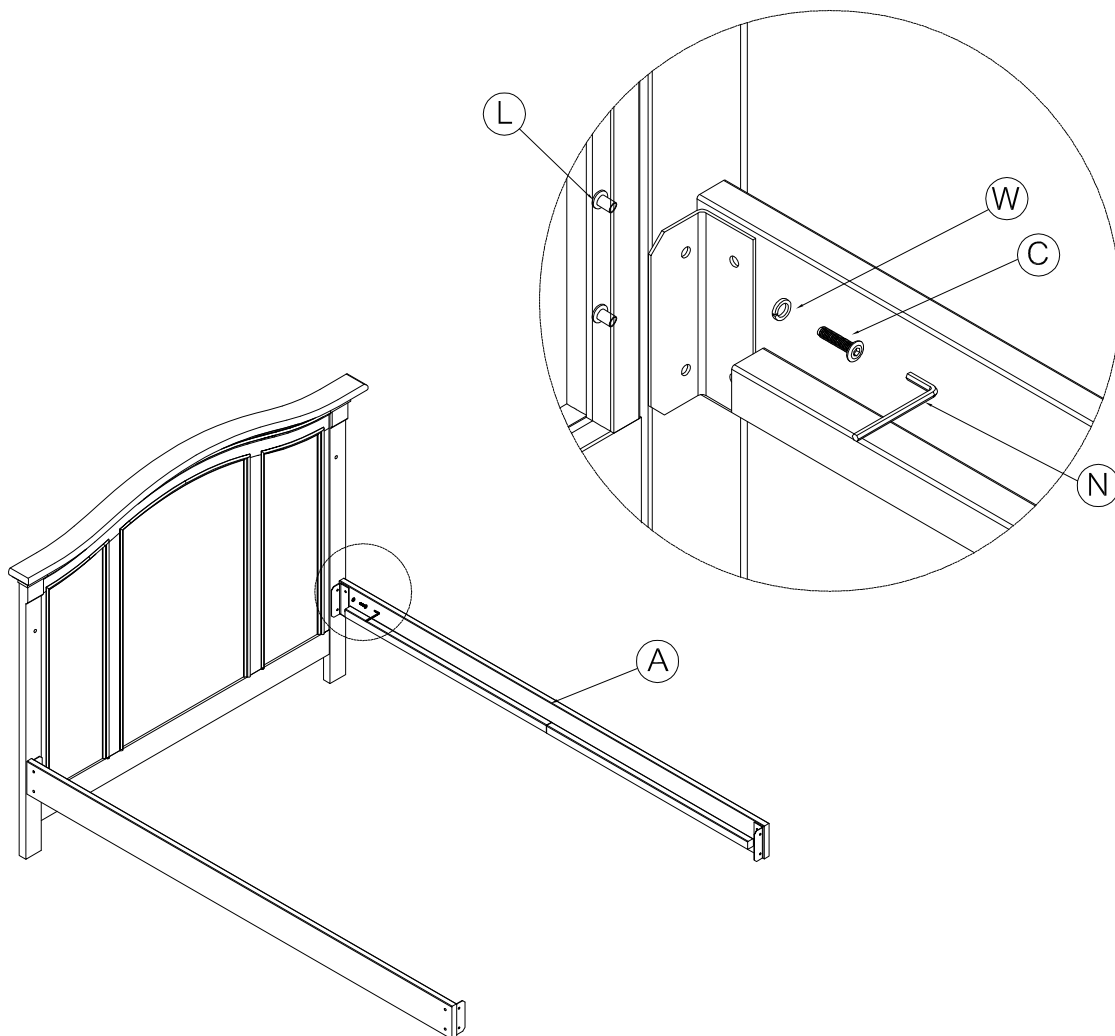
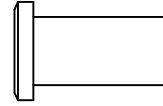
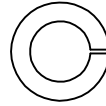

- Insert Allenbolt 1" (25 mm) (C) with spring washer (W) through the metal bracket holes in the end of side rail through the top & bottom holes in headboard and connect with nut 3/4" (20 mm) (L).
Hand tighten only

STEP 2 " ASSEMBLY OF FOOTBOARD "

THIS STEP REQUIRES :

Footboard (1 pc)

N. Allenkey (2 pcs)

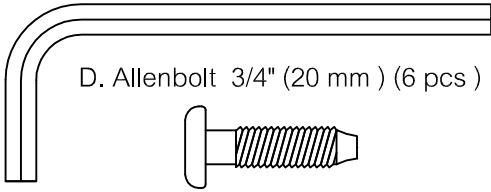

D. Allenbolt 3/4" (20 mm) (6 pcs)

L. Nut 3/4" (20 mm) (2 pcs)

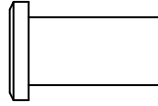

W. Spring Washer (4 pcs)

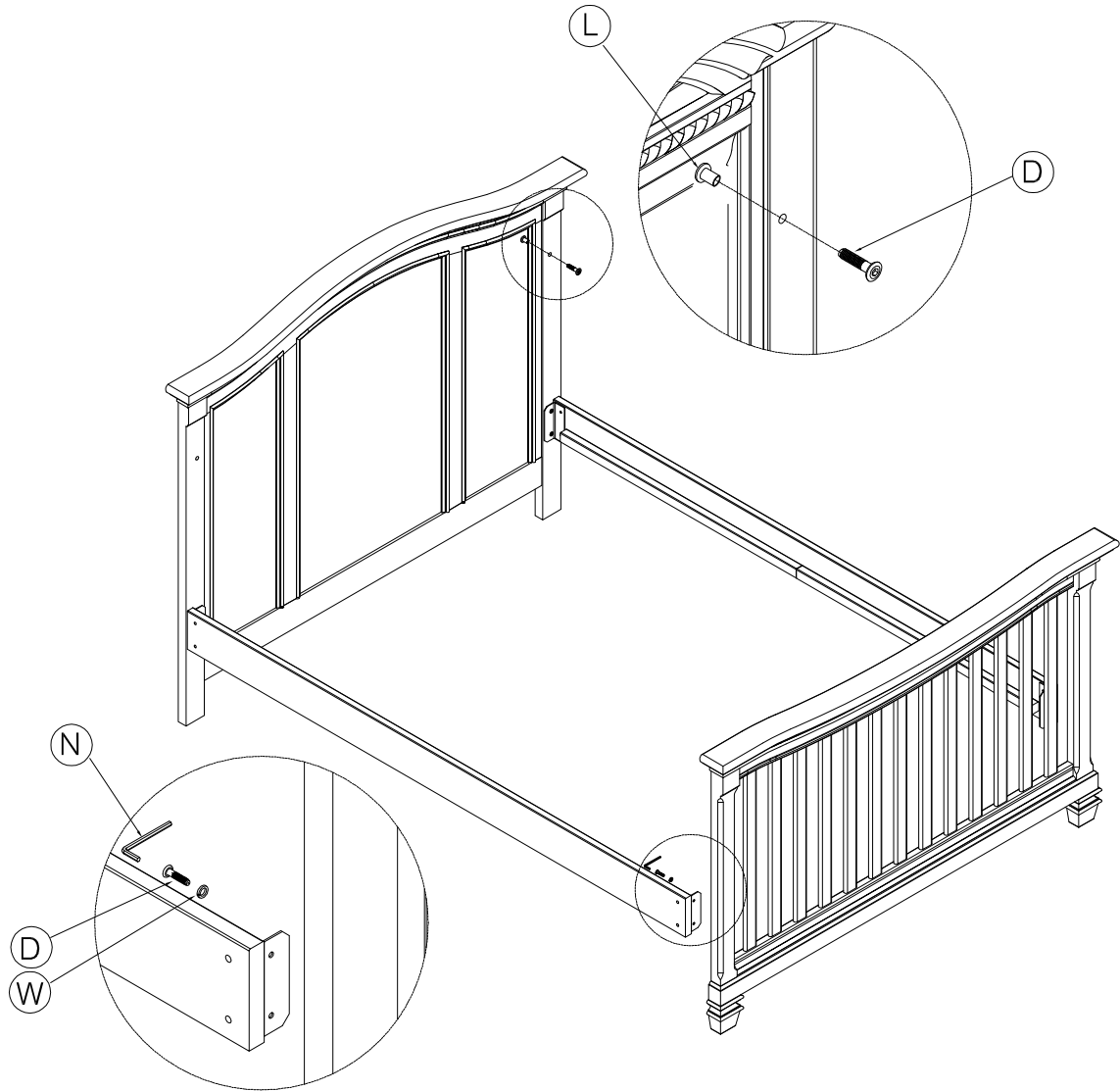
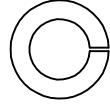

- Insert Allenbolt 3/4" (20 mm) (D) with spring washer (W) through the metal bracket holes in the end of side rail through the threaded holes in the footboard.
- Tighten all bolts with allenkey (N).
- Insert Allenbolt 3/4" (20 mm) (D), through the top hole in the headboard from the inside and connect with nut 3/4" (20 mm) (L).
Tighten all bolts and nuts with allenkey (N).

STEP 3 " ASSEMBLY OF SLATS "

THIS STEP REQUIRES :

B. Slats (5 pcs)

G. Screw 1 1/4" (30 mm) (10 pcs)

Screw Driver
(Unsupplied)

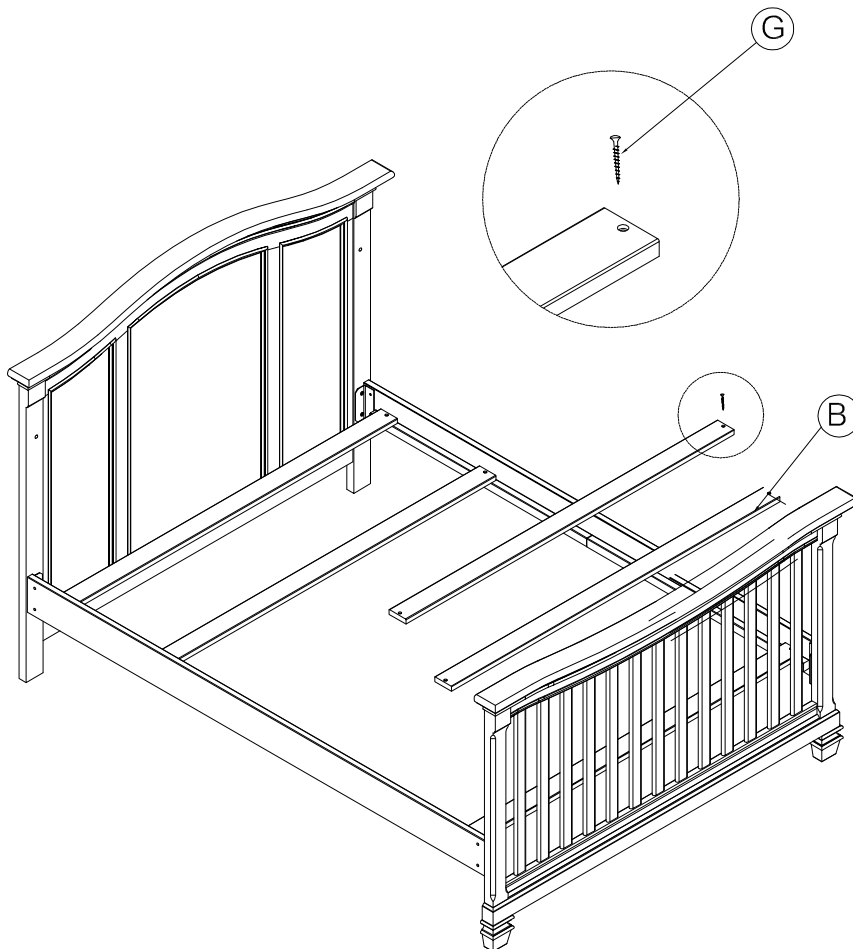
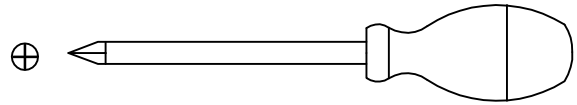
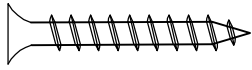

- Install 5 pcs of slats (B) to the 2 pcs of side rail above the pre drilling holes.
- Insert 10 pcs of screw 1 1/4" (30 mm) (G) screws into the slats holes through side rail pre drilling holes. Hand tighten only
- After all 10 pcs of screw inserted, fasten with screw driver.