

ASSEMBLY INSTRUCTIONS

for Guard Rail

GLENDALE

Model # 23575

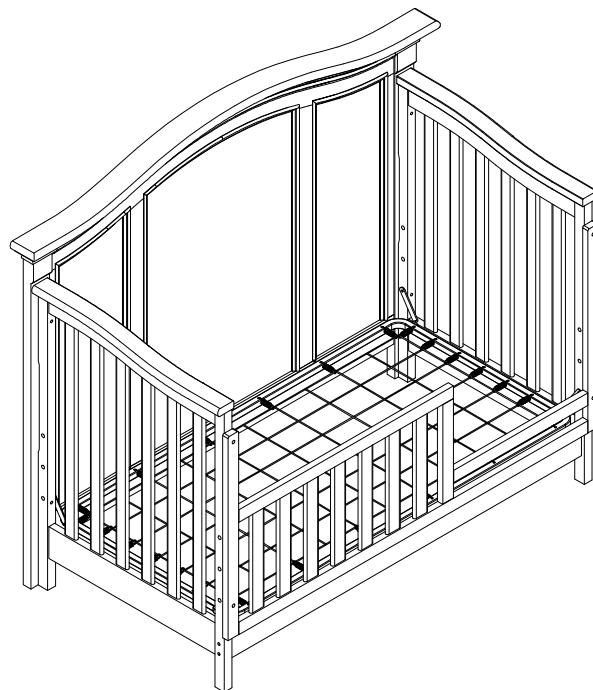

"THE PRODUCT IMAGES SHOWN ARE FOR ILLUSTRATION PURPOSES ONLY AND MAY NOT BE AN EXACT REPRESENTATION OF THE PRODUCT."

Carefully remove and lay out all parts. Familiarize yourself with all exhibits and diagrams to facilitate the assembly of your crib

TOOLS REQUIRED :

Allenkey (supplied)

PART ENCLOSED IN CARTON

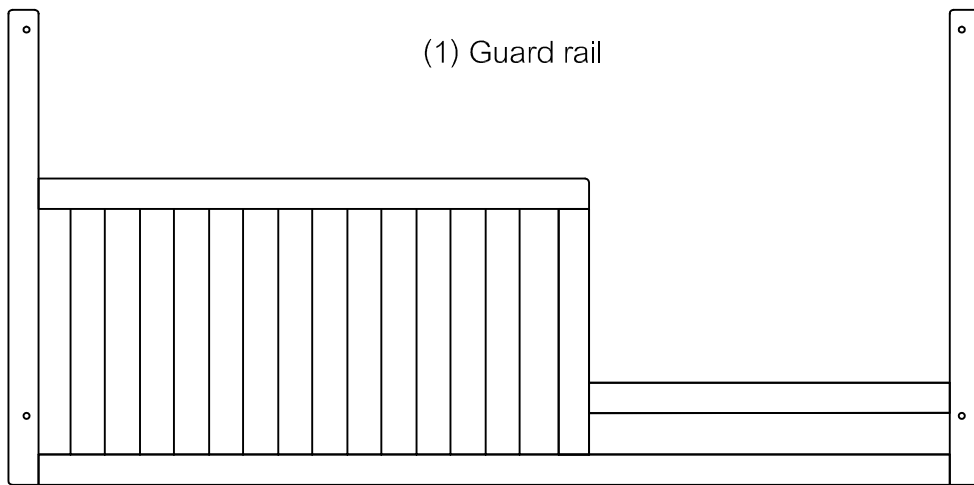

HARDWARE

(N) Allenkey (2 pcs) (length may vary)



(H) Allenbolt 2" (50 mm) (4 pcs)



(L) Nut 3/4" (20 mm) (4 pcs)

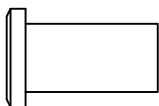

(W) Spring Washer (4 pcs)

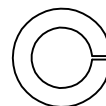

Make sure the bolts are tightly locked against the washers during assembly.

(Please add an extra 1/2 revolution to all the bolts when using spring washer after tightening)

STEP 1 " UNINSTALL FOOTBOARD "

THIS STEP REQUIRES :

Allenkey (1 pc)



FIG. 1 .

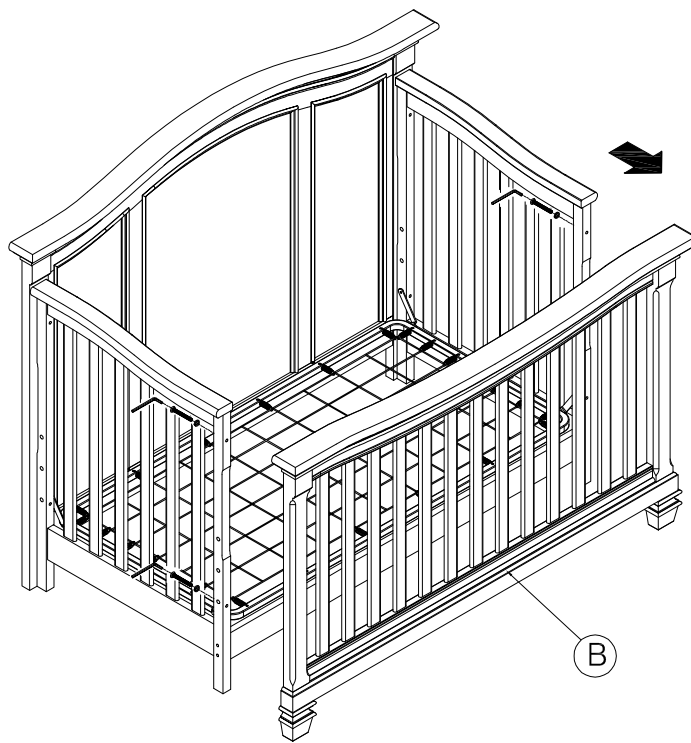

- Remove the footboard by unscrewing the (4 pcs) allenbolts as shown in FIG.1.

STEP 2 " MATTRESS SUPPORT HEIGHT ADJUSTMENT "

THIS STEP REQUIRES :

These hardware are included in the CRIB

N. Allenkey (2 pcs)

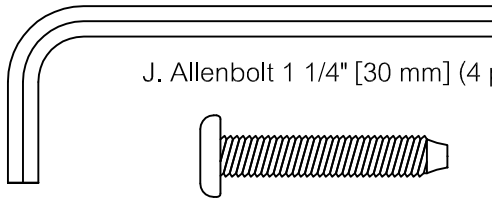

J. Allenbolt 1 1/4" [30 mm] (4 pcs)

L . Nut 3/4" [20 mm] (4 pcs)

W. Spring Washer (4 pcs)

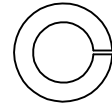
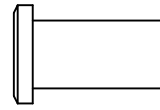

FIG. 2.2

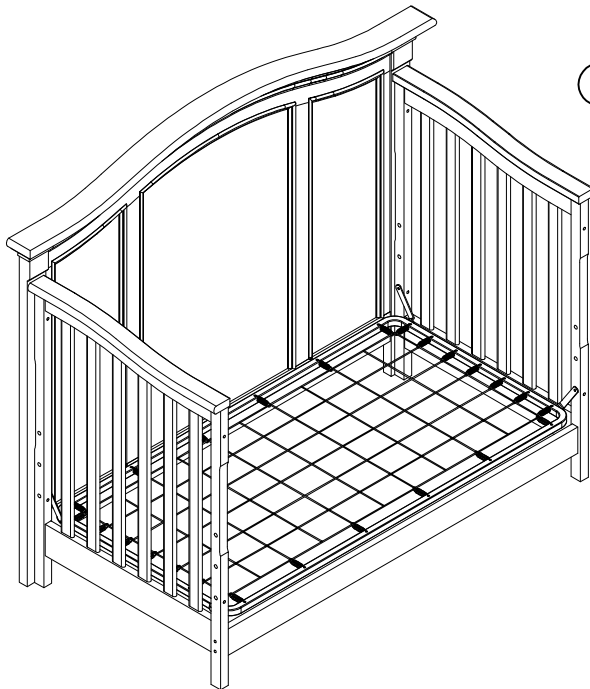
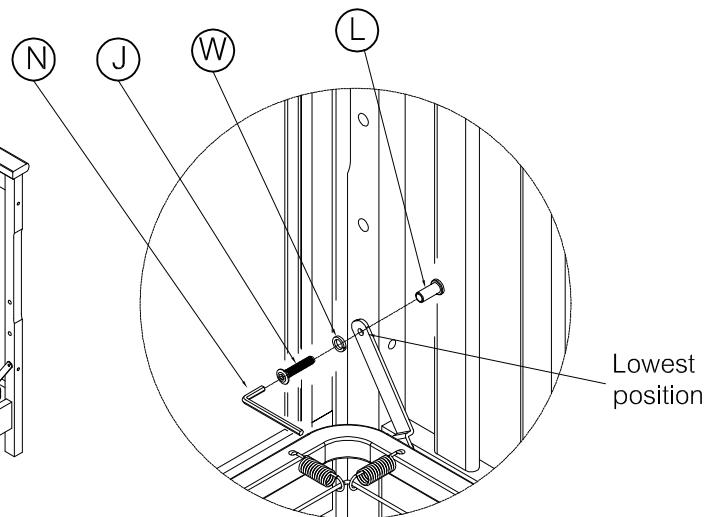

FIG. 2.1



- Remove the allenbolt 1 1/4" (30 mm) (J), spring washer (W) and nut 3/4" (20 mm) (L) on the mattress spring.
- Move mattress spring to the lowest position as shown in FIG.2.1.
- Attach the allen bolt 1 1/4" (30 mm) (J), spring washer (W) and nut 3/4" (20 mm) (L) on the lowest hole of side frame.
- Tighten all bolts with allenkey (N)
- Final position as shown in FIG.2.2

STEP 3 " ASSEMBLY OF GUARD RAIL "

THIS STEP REQUIRES :

N. Allenkey (2 pcs)

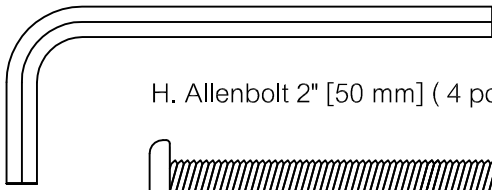

H. Allenbolt 2" [50 mm] (4 pcs)

L . Nut 3/4" [20 mm] (4 pcs)

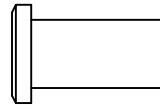

W. Spring Washer (4 pcs)

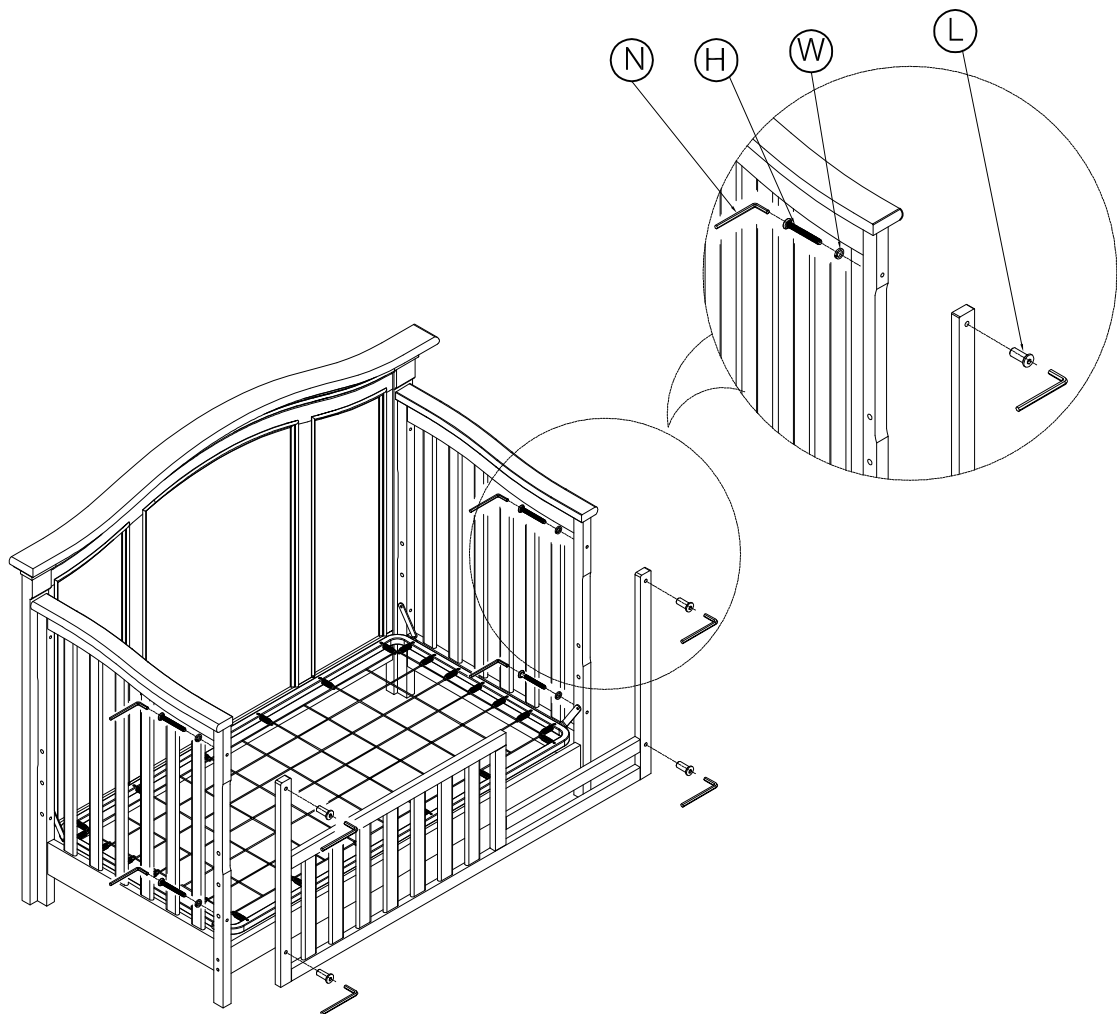
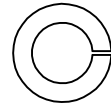

- Insert the Allenbolt 2 " (50 mm) (H) & spring washer (W) through the top and bottom hole in the crib side board and guardrail and connect with nut 3/4" (20 mm) (L). Tighten all bolts and nuts with allenkey (N).

 **“CAUTION: ANY MATTRESS USED IN THIS CRIB MUST BE AT LEAST 27 1/4 INCHES (69 CM) BY 51 5/8 INCHES (131 CM) WITH A THICKNESS NOT EXCEEDING 6 INCHES (15 CM). THE DIMENSIONS OF THE MATTRESS SHALL BE TAKEN FROM SEAM TO SEAM OR EDGE TO EDGE WHERE APPROPRIATE.”**

 **WARNING!**
FOR TODDLER BED USE

- READ ALL INSTRUCTIONS BEFORE ASSEMBLING TODDLER BED.
KEEP INSTRUCTIONS FOR FUTURE USE.
- FAILURE TO FOLLOW THESE WARNINGS AND THE ASSEMBLY INSTRUCTIONS COULD RESULT IN SERIOUS INJURY OR DEATH FROM ENTRAPMENT OR STRANGULATION.
- **CAUTION:** THE MATTRESS INTENDED FOR USE ON THE BED SHALL BE A FULL-SIZE CRIB MATTRESS HAVING MINIMUM DIMENSIONS OF 51 5/8 INCHES (1310 MM) IN LENGTH AND 27 1/4 INCHES (690 MM) IN WIDTH AND NOT EXCEEDING 6 INCHES (150 MM) IN THICKNESS. THE DIMENSIONS OF THE MATTRESS SHALL BE TAKEN FROM SEAM TO SEAM OR EDGE TO EDGE WHERE APPROPRIATE.
- THE MINIMUM AGE OF THE INTENDED USER SHALL NOT BE LESS THAN 15 MONTHS AND THE MAXIMUM WEIGHT SHALL NOT BE GREATER THAN 50 LB (22.7 KG).
- **GUARDRAIL (SOLD SEPARATELY) MUST BE USED** WHEN CRIB USED AS A TODDLER BED TO AVOID THE FORMATION OF A GAP BETWEEN THE MATTRESS AND THE BED THAT COULD CAUSE AN ENTRAPMENT.
- DO NOT PLACE BED NEAR WINDOWS WHERE CORDS FROM BLINDS OR DRAPES MAY STRANGLE A CHILD.
- **DO NOT** PLACE ITEMS WITH A STRING, CORD, OR RIBBON AROUND A CHILD'S NECK, SUCH AS HOOD STRINGS OR PACIFIER CORDS.
- **DO NOT** SUSPEND STRINGS OVER A TODDLER BED FOR ANY REASON.
- WHEN STORING TODDLER BED USE CAUTION AS EXTREME CHANGE IN TEMPERATURE OR HUMIDITY CAN COMPROMISE THE TODDLER BED MAKING IT EXTREMELY DANGEROUS TO YOUR CHILD. STORE THE TODDLER BED IN A CLEAN DRY PLACE.
- USE CAUTION WHEN A VAPORIZER OR HUMIDIFIER IS IN USE. ALWAYS AIM VAPOR AWAY FROM THE TODDLER BED AS WELL AS ANY OTHER WOODEN FURNITURE. PROLONGED PERIODS OF HUMIDITY IN STORAGE AS WELL AS THE HOME CAN COMPROMISE THE TODDLER BED.
- AVOID USING VAPORIZERS AND HUMIDIFIER FOR PROLONGED PERIODS OF TIME.
- PLEASE DISPOSE ALL PACKAGING AND PLASTIC BAGS.
- PLEASE CLEAN THE TODDLER BED WITH A DRY CLOTH AND USE MILD WOOD POLISH IF REQUIRED.
- **PREVENT BURNS.** KEEP BED AWAY FROM OPEN FIRES AND OTHER HEAT SOURCES.
- CHECK THIS PRODUCT FOR DAMAGED HARDWARE, LOOSE JOINTS, LOOSE BOLTS OR OTHER FASTENERS, MISSING PARTS OR SHARP EDGES BEFORE AND AFTER ASSEMBLY AND FREQUENTLY DURING USE. SECURELY TIGHTEN LOOSE BOLTS AND OTHER FASTENERS. **DO NOT** USE CRIB IF ANY PARTS ARE MISSING, DAMAGED OR BROKEN. CONTACT BABY CACHE, 91 NEW ENGLAND AVENUE, PISCATAWAY, NEW JERSEY 08854; PHONE: 732-339-6077; EMAIL: INFO@BABYCACHE.COM FOR REPLACEMENT PARTS AND INSTRUCTIONAL LITERATURE IF NEEDED. **DO NOT** SUBSTITUTE PARTS.

WARNING ENTRAPMENT/STRANGULATION HAZARD

- INFANTS HAVE DIED IN TODDLER BEDS FROM ENTRAPMENT AND STRANGULATION.
- FAILURE TO FOLLOW THESE WARNINGS AND THE ASSEMBLY INSTRUCTIONS COULD RESULT IN SERIOUS INJURY OR DEATH.
- **NEVER** USE BED WITH CHILDREN UNDER 15 MONTHS.
- **NEVER** PLACE BED NEAR WINDOWS WHERE CORDS FROM BLINDS OR DRAPES MAY STRANGLE A CHILD.

WARNING

INFANTS HAVE DIED IN TODDLER BEDS FROM ENTRAPMENT.

- OPENINGS IN AND BETWEEN BED PARTS CAN ENTRAP HEAD AND NECK OF A SMALL CHILD.
- **NEVER** USE BED WITH CHILDREN YOUNGER THAN 15 MONTHS.
- **ONLY** USE FULL-SIZE CRIB MATTRESS OF THE RECOMMENDED SIZE.
- **ALWAYS** FOLLOW ASSEMBLY INSTRUCTIONS.

WARNING

STRANGULATION HAZARD

- **NEVER** PLACE BED NEAR WINDOWS WHERE CORDS FROM BLINDS OR DRAPES MAY STRANGLE A CHILD.
- **NEVER** SUSPEND STRINGS OVER BED.
- **NEVER** PLACE ITEMS WITH A STRING, CORD, OR RIBBON, SUCH AS HOOD STRINGS OR PACIFIER CORDS, AROUND A CHILD'S NECK. THESE ITEMS MAY CATCH ON BED PARTS.