

ASSEMBLY INSTRUCTIONS HUTCH

HARDWARE

Screw 3/4"(20mm.) (2pcs.)
(Attached)

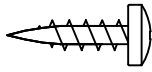

Screw Driver (Not Included)

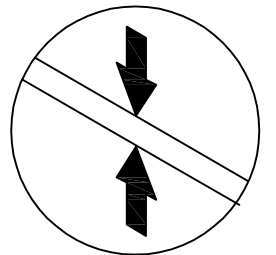
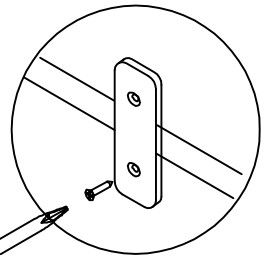
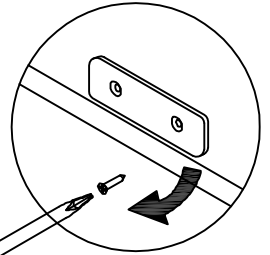
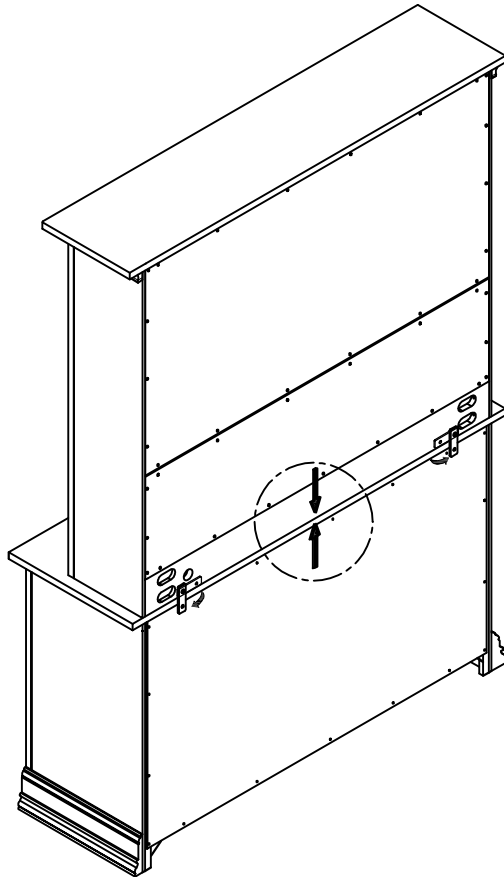
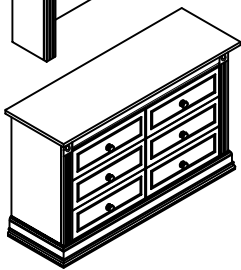
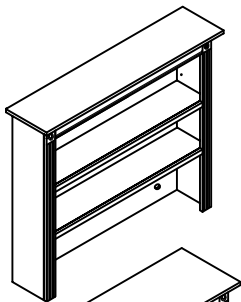
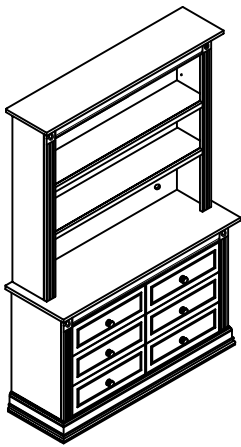
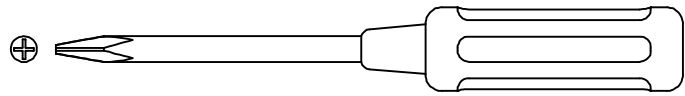

B. Metal plate already attached at HUTCH behind.
Pull out 1 screw at each metal plate,
take around to bottom side,
attached again screw & back plate to DRESSER.

RED ARROW STICKER
(ALREADY ATTACHED)

NOTE : YOU CAN APPLY YOUR HUTCH WITH "COMBO"
OR "DRESSER"

A. Put the hutch to the top of case good
(example : dresser) in back side.

