

# ASSEMBLY INSTRUCTIONS

## for 4 in 1 life time<sup>®</sup> Crib

### OVERLAND

#### Model # 11100



GUARDRAIL and CONVERSION KIT sold separately.  
Please contact retailer.

**THIS PRODUCT CONFORMS TO THE APPLICABLE SECTIONS OF PUBLIC LAW 110-314 AND COMPLIES WITH THE REQUIREMENTS STATED IN 16 CFR 1219 AND 16 CFR 1217 (WHEN OVERLAND GUARDRAIL IS USED).**

Carefully remove and lay out all parts. Familiarize yourself with all exhibits and diagrams to facilitate the assembly of your crib

TOOLS REQUIRED :  
Allenkey ( supplied)

**PART ENCLOSED IN CARTON**

A. Head Board ( 1 pc )

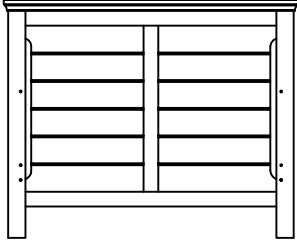

C. Side Board ( 2 pcs )

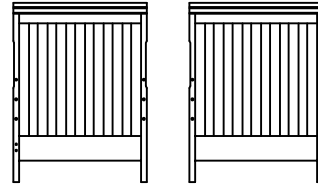

B. Foot Board ( 1 pc )

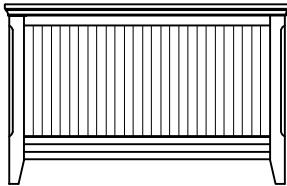

D. Stabilizer Bar ( 1 pc )



E. Mattress Spring ( 1 pc )

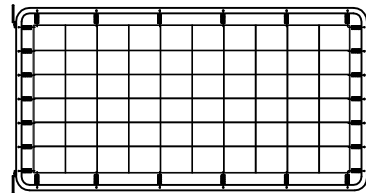

**HARDWARE**

( F ) Allenbolt 2 1/4" (55 mm) (4 pcs )



( W ) Spring Washer ( 16 pcs )

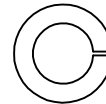

( G ) Allenbolt 2 3/4 " [ 70 mm ] (4 pcs )



( L ) Nut 3/4" [20 mm] ( 8 pcs )

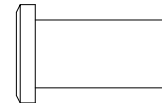

( H ) Allenbolt 1 1/2" [40 mm] (4 pcs)



( M ) Barrel Nut 5/8" (15 mm x 16 mm ) (4 pcs )

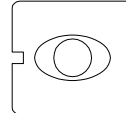

( J ) Allenbolt 1" [25 mm] (4 pcs)



( N ) Allenkey (2 pcs ) (Length may vary)



Make sure the bolts are tightly locked against the washers during assembly.  
( Please add an extra 1/2 revolution to all the bolts when using spring washer after tightening)

## STEP 1 " ASSEMBLY OF CRIB SIDES "

### THIS STEP REQUIRES :

A. Head Board (1 pc)  
 C. Side Board (2 pcs)  
 D. Stabilizer Bar (1 pc)  
 N. Allenkey (2 pcs)

F. Allenbolt 2 1/4 " (55 mm) (4 pcs)

M. Barrel Nut 5/8" (15 mm x 16 mm)  
 (4 pcs)

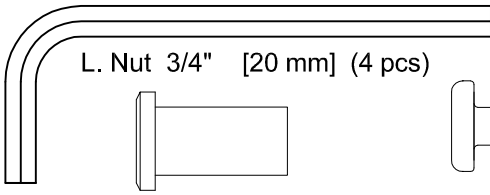
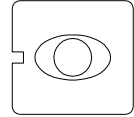
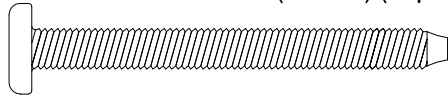

L. Nut 3/4" [20 mm] (4 pcs)

G. Allenbolt 2 3/4 " [70 mm] (4 pcs)

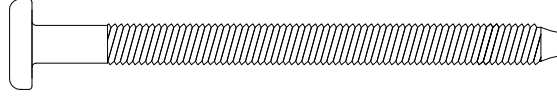

W. Spring Washer (8 pcs)

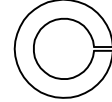

### STEP 1.1

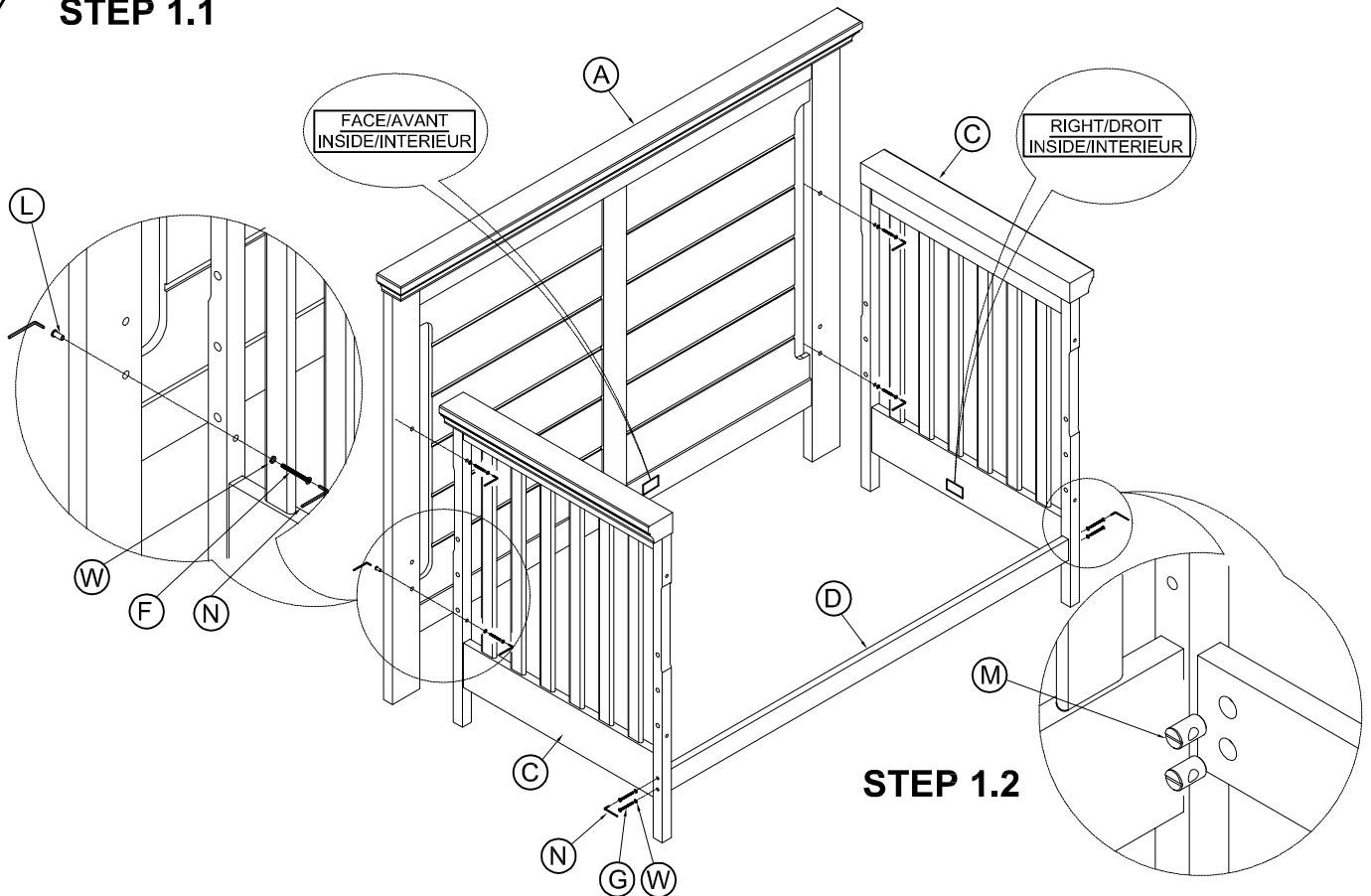

### STEP 1.2

#### STEP 1.1

- Insert nut 3/4" [20 mm] ( L ) through the top and bottom holes in headboard from the back side.
- Insert allenbolt 2 1/4" [55 mm] ( F ), spring washer ( W ) through the top and bottom holes in sideboard and connect to the headboard. Hand tighten only!
- Repeat STEP 1.1 for other sideboard.

#### STEP 1.2

- Insert barrel nut 5/8" (15 mm x 16 mm) ( M ) into holes in stabilizer bar
- Connect stabilizer bar to the sideboard using (4 pcs) allenbolt 2 3/4" [70 mm] ( G ), and spring washer ( W )
- Tighten all bolts with allenkey ( N )

## STEP 2 " SPRING INSTALLATION "

### THIS STEP REQUIRES :

E. Mattress Spring ( 1 pc)

N. Allenkey ( 2 pcs)

J. Allenbolt 1" [25 mm] ( 4 pcs)

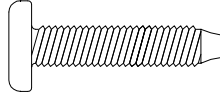

L . Nut 3/4" [20 mm] ( 4 pcs)

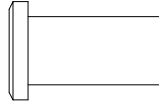

W. Spring Washer ( 4 pcs)

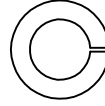

FIG. 3 .

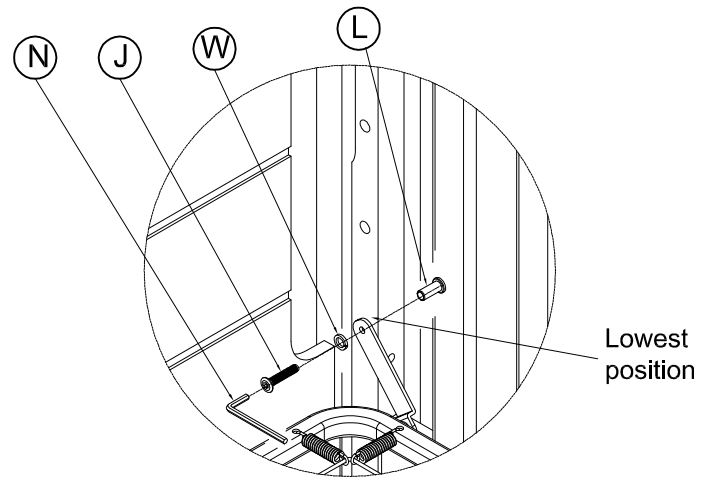
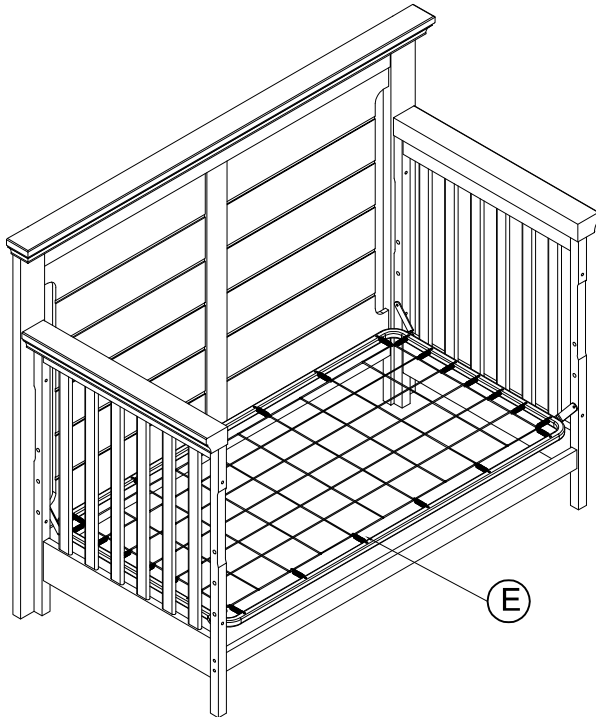
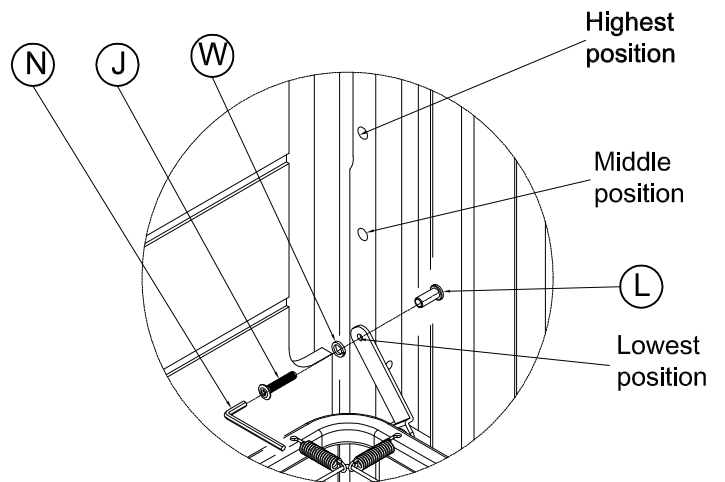

FIG. 4 .



- Attach mattress spring (E) to Side board as shown in FIG.3.
- Secure with allenkey (N).
- See FIG. 4 for height adjustment
- Make sure the mattress spring is leveled after assembly.

## STEP 3 " ASSEMBLY OF FOOTBOARD "

THIS STEP REQUIRES :

B. Footboard ( 1 pc)

N. Allenkey ( 1 pc)

H . Allenbolt 1 1/2 " [ 40 mm ] ( 4 pcs )

W. Spring Washer ( 4 pcs)

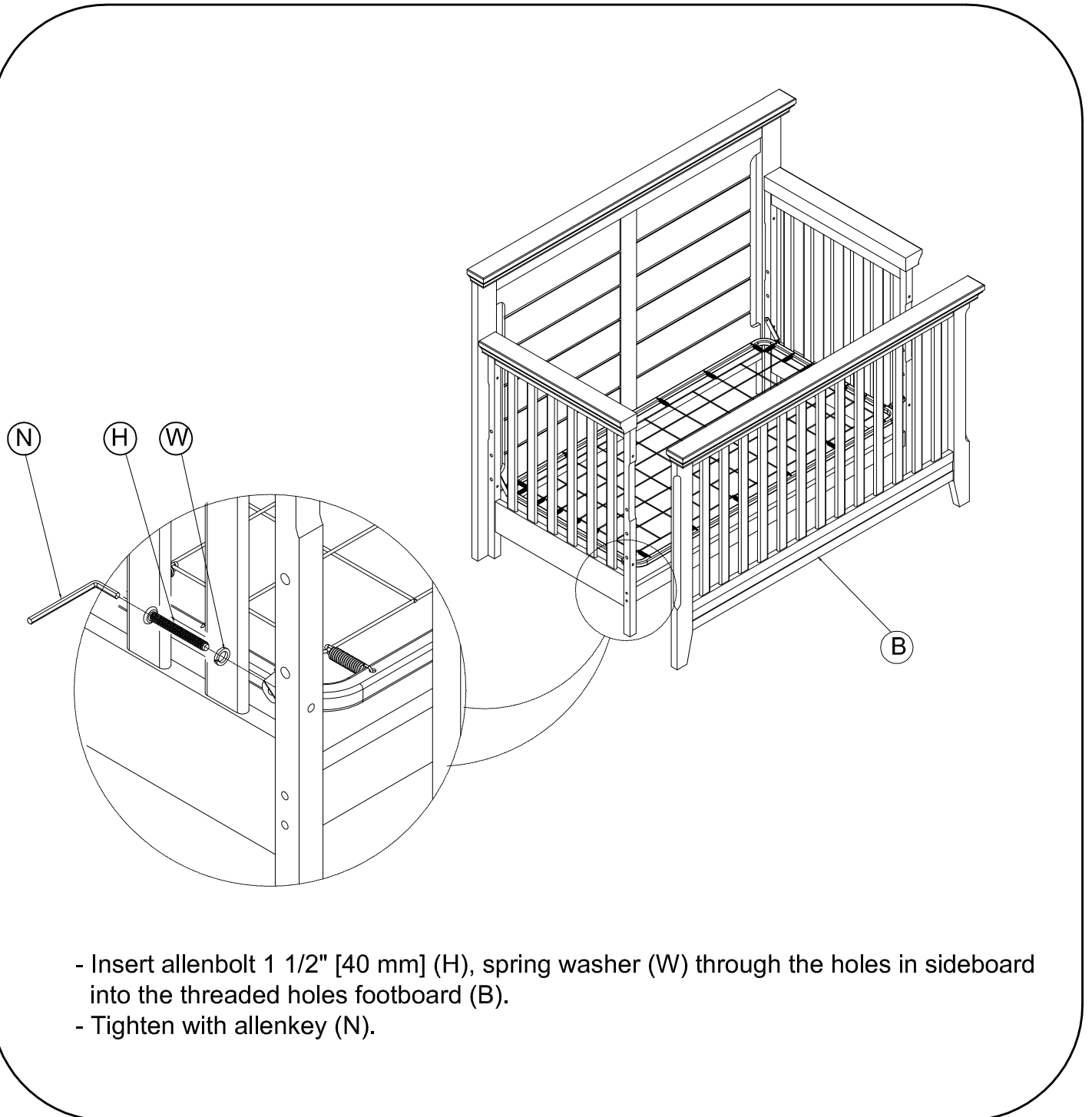
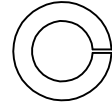
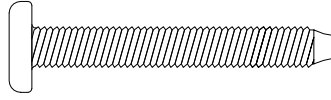
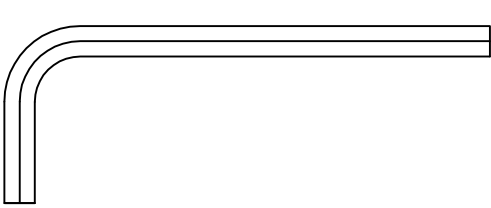

- Insert allenbolt 1 1/2" [40 mm] (H), spring washer (W) through the holes in sideboard into the threaded holes footboard (B).
- Tighten with allenkey (N).

 **“CAUTION: ANY MATTRESS USED IN THIS CRIB MUST BE AT LEAST 27 1/4 INCHES (69 CM) BY 51 5/8 INCHES (131 CM) WITH A THICKNESS NOT EXCEEDING 6 INCHES (15 CM). THE DIMENSIONS OF THE MATTRESS SHALL BE TAKEN FROM SEAM TO SEAM OR EDGE TO EDGE WHERE APPROPRIATE.”**

 **WARNING!**

- READ ALL INSTRUCTIONS BEFORE ASSEMBLING CRIB.  
**KEEP INSTRUCTIONS FOR FUTURE USE.**
  - FAILURE TO FOLLOW THESE WARNINGS AND THE ASSEMBLY INSTRUCTIONS COULD RESULT IN SERIOUS INJURY OR DEATH.
  - INFANTS CAN SUFFOCATE ON SOFT BEDDING. NEVER ADD A PILLOW OR COMFORTER. NEVER PLACE ADDITIONAL PADDING UNDER AN INFANT.
  - TO REDUCE THE RISK OF **SIDS**, PEDIATRICIANS RECOMMEND HEALTHY INFANTS BE PLACED ON THEIR BACKS TO SLEEP, UNLESS OTHERWISE ADVISED BY YOUR PHYSICIAN.
- 
- STRANGULATION HAZARD:**
- STRINGS CAN CAUSE STRANGULATION! **DO NOT** PLACE ITEMS WITH A STRING AROUND A CHILD'S NECK, SUCH AS HOOD STRINGS OR PACIFIER CORDS. **DO NOT** SUSPEND STRINGS OVER A CRIB OR ATTACH STRINGS TO TOYS.
  - TO HELP PREVENT STRANGULATION TIGHTEN ALL FASTENERS. A CHILD CAN TRAP PARTS OF THE BODY OR CLOTHING ON LOOSE FASTENERS.
  - **DO NOT** PLACE CRIB NEAR WINDOW WHERE CORDS FROM BLINDS OR DRAPES MAY STRANGLE A CHILD.
- 
- FALL HAZARD:**
- WHEN CHILD IS ABLE TO PULL TO A STANDING POSITION, SET MATTRESS TO LOWEST POSITION AND REMOVE BUMPERS PADS, LARGE TOYS AND OTHER OBJECTS THAT COULD SERVE AS STEPS FOR CLIMBING OUT.
  - STOP USING CRIB WHEN CHILD BEGINS TO CLIMB OUT OR REACHES THE HEIGHT OF 35 IN (89 CM). THE CHILD SHOULD BE PLACED IN A YOUTH OR REGULAR BED.
- 
- CHECK THIS PRODUCT FOR DAMAGED HARDWARE, LOOSE JOINTS, LOOSE BOLTS OR OTHER FASTENERS, MISSING PARTS OR SHARP EDGES, BEFORE AND AFTER ASSEMBLY AND FREQUENTLY DURING USE. SECURELY TIGHTEN LOOSE BOLTS AND OTHER FASTENERS. **DO NOT** USE CRIB IF ANY PARTS ARE MISSING, DAMAGED OR BROKEN. CONTACT BABY CACHE, 91 NEW ENGLAND AVENUE, PISCATAWAY, NEW JERSEY 08854, PHONE: 732-339-6077 ; EMAIL : [INFO@BABYCACHE.COM](mailto:INFO@BABYCACHE.COM) FOR REPLACEMENT PARTS AND INSTRUCTIONAL LITERATURE IF NEEDED. **DO NOT** SUBSTITUTE PARTS.
  - **DO NOT** USE A WATER MATTRESS WITH THIS CRIB.

# **WARNING!**

- IF REFINISHING, USE A NON-TOXIC FINISH SPECIFIED FOR CHILDREN'S PRODUCTS.
- FOLLOW WARNINGS ON ALL PRODUCTS IN A CRIB.  
UPON COMPLETION OF ASSEMBLY, BE SURE ALL SCREWS, BOLT AND FASTENING DEVICES HAVE BEEN SECURELY TIGHTENED. A FREQUENT CHECK SHOULD BE MADE.
- WHEN STORING CRIB, USE CAUTION AS EXTREME CHANGE IN TEMPERATURE OR HUMIDITY CAN COMPROMISE THE CRIB, MAKING IT EXTREMELY DANGEROUS TO YOUR CHILD. STORE THE CRIB IN A CLEAN DRY PLACE.
- USE CAUTION WHEN A VAPORIZER OR HUMIDIFIER IS IN USE. ALWAYS AIM VAPOR AWAY FROM THE CRIB AS WELL AS ANY OTHER WOODEN FURNITURE. PROLONGED PERIODS OF HUMIDITY IN STORAGE AS WELL AS THE HOME CAN COMPROMISE THE CRIB.
- AVOID USING VAPORIZERS AND HUMIDIFIER FOR PROLONGED PERIODS OF TIME.
- PLEASE DISPOSE ALL PACKAGING AND PLASTIC BAGS.
- PLEASE CLEAN THE CRIB WITH A DRY CLOTH AND USE MILD WOOD POLISH IF REQUIRED.
- NEVER USE PLASTIC SHIPPING BAGS OR OTHER PLASTIC FILM AS MATTRESS COVERS BECAUSE THEY CAN CAUSE SUFFOCATION.
- INFANTS CAN SUFFOCATE IN GAPS BETWEEN CRIB SIDES AND A MATTRESS THAT IS TOO SMALL.

## **WARNING**

DO NOT USE THIS CRIB IF THE ENCLOSED OR ATTACHED INSTRUCTIONS CANNOT BE STRICTLY ADHERED TO. DO NOT USE THIS CRIB IF THE CHILD IS ABLE TO CLIMB OUT UNAIDED OR IS TALLER THAN 90 CM. DO NOT PLACE CORDS, STRAPS OR SIMILAR ITEMS THAT COULD BECOME WOUND AROUND THE CHILD'S NECK IN OR NEAR THIS CRIB. ENSURE THAT THE SIDES ARE PROPERLY LATCHED OR LOCKED IN PLACE WHEN THE CRIB IS OCCUPIED. THE MATTRESS USED WITH THIS CRIB SHOULD NOT BE MORE THAN 15 CM THICK AND SHOULD BE OF SUCH LENGTH AND WIDTH THAT THE GAP BETWEEN THE MATTRESS AND THE SIDES OF THE CRIB IS NOT MORE THAN 3 CM WHEN THE MATTRESS IS PUSHED INTO THE CORNER OF THE CRIB.

**AS PARENTS IT IS YOUR RESPONSIBILITY TO ENSURE YOUR CHILD IS IN A SAFE ENVIRONMENT. CHECK REGULARLY BEFORE PLACING THE CHILD IN CRIB THAT ALL SIDE, MATTRESS SUPPORTS AND BOLTS ARE IN PLACE AND PROPERLY SECURED.**

**ASSEMBLY INSTRUCTIONS**  
for Toddler Bed  
**OVERLAND**  
Model # 11100

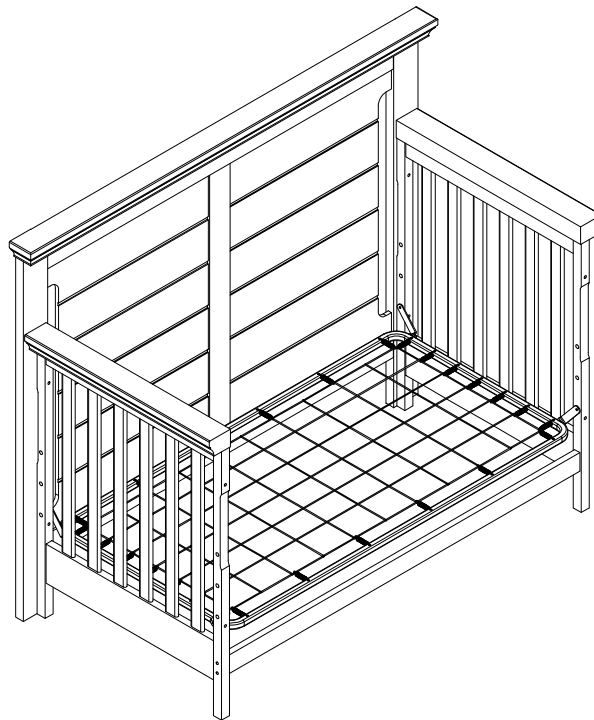

GUARDRAIL and CONVERSION KIT sold separately.  
Please contact retailer.



# STEP 1 " UNINSTALL FOOTBOARD "

THIS STEP REQUIRES :

Allenkey ( 1 pc)



FIG. 1 .

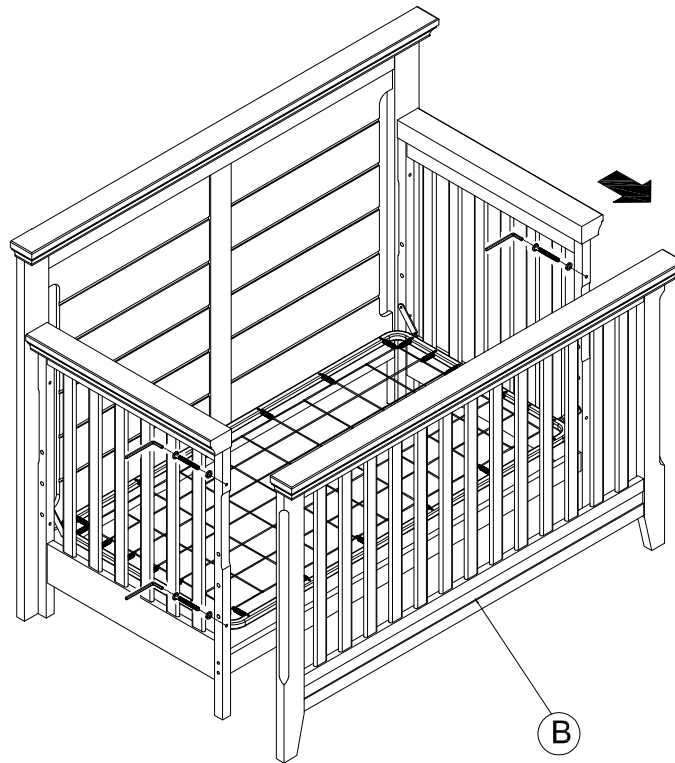

- Remove the footboard by unscrewing the ( 4 pcs) allenbolts as shown in FIG.1.

## STEP 2 " MATTRESS SUPPORT HEIGHT ADJUSTMENT "

### THIS STEP REQUIRES :

These hardware are included in the CRIB

N. Allenkey ( 2 pcs)

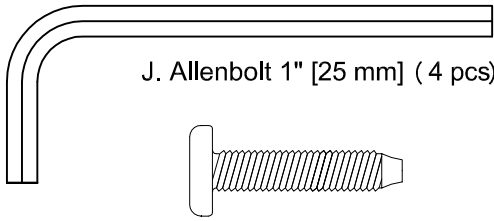

J. Allenbolt 1" [25 mm] ( 4 pcs)

L . Nut 3/4" [20 mm] ( 4 pcs)

W. Spring Washer ( 4 pcs)

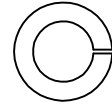
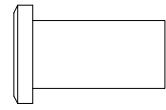

FIG. 3 .

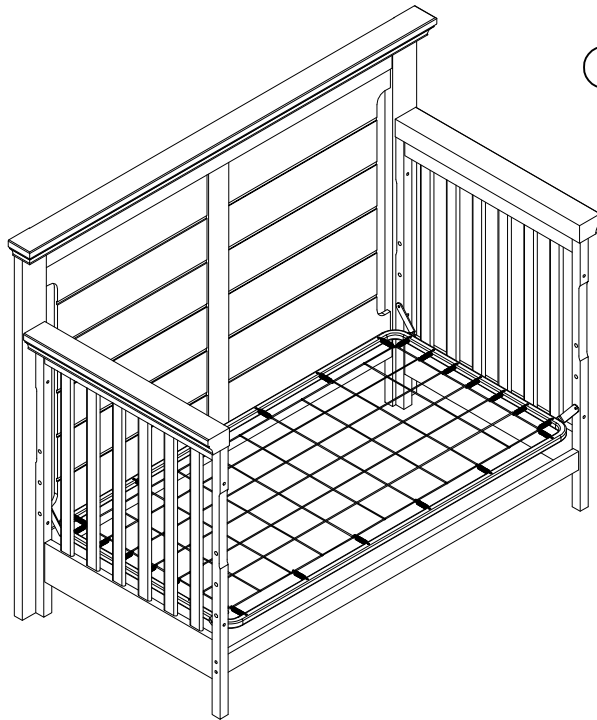
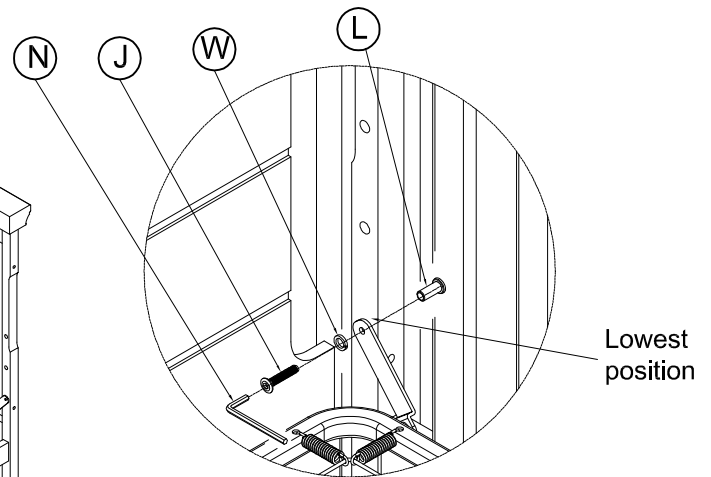



FIG. 2 .



- Remove the allenbolt 1" (25 mm) ( J ), spring washer ( W ) and nut 3/4" (20 mm) ( L ) on the mattress spring.
- Move mattress spring to the lowest position as shown in FIG.2.
- Attach the allen bolt 1" (25 mm) ( J ), spring washer ( W ) and nut 3/4" (20 mm) ( L ) on the lowest hole of side frame.
- Final position as shown in FIG.3.

 **“CAUTION: ANY MATTRESS USED IN THIS CRIB MUST BE AT LEAST 27 1/4 INCHES (69 CM) BY 51 5/8 INCHES (131 CM) WITH A THICKNESS NOT EXCEEDING 6 INCHES (15 CM). THE DIMENSIONS OF THE MATTRESS SHALL BE TAKEN FROM SEAM TO SEAM OR EDGE TO EDGE WHERE APPROPRIATE.”**

 **WARNING!**  
FOR TODDLER BED USE

- READ ALL INSTRUCTIONS BEFORE ASSEMBLING TODDLER BED.  
**KEEP INSTRUCTIONS FOR FUTURE USE.**
- FAILURE TO FOLLOW THESE WARNINGS AND THE ASSEMBLY INSTRUCTIONS COULD RESULT IN SERIOUS INJURY OR DEATH FROM ENTRAPMENT OR STRANGULATION.
- **CAUTION:** THE MATTRESS INTENDED FOR USE ON THE BED SHALL BE A FULL-SIZE CRIB MATTRESS HAVING MINIMUM DIMENSIONS OF 51 5/8 INCHES (1310 MM) IN LENGTH AND 27 1/4 INCHES (690 MM) IN WIDTH AND NOT EXCEEDING 6 INCHES (150 MM) IN THICKNESS. THE DIMENSIONS OF THE MATTRESS SHALL BE TAKEN FROM SEAM TO SEAM OR EDGE TO EDGE WHERE APPROPRIATE.
- THE MINIMUM AGE OF THE INTENDED USER SHALL NOT BE LESS THAN 15 MONTHS AND THE MAXIMUM WEIGHT SHALL NOT BE GREATER THAN 50 LB (22.7 KG).
- **GUARDRAIL (SOLD SEPARATELY) MUST BE USED** WHEN CRIB USED AS A TODDLER BED TO AVOID THE FORMATION OF A GAP BETWEEN THE MATTRESS AND THE BED THAT COULD CAUSE AN ENTRAPMENT.
- DO NOT PLACE BED NEAR WINDOWS WHERE CORDS FROM BLINDS OR DRAPES MAY STRANGLE A CHILD.
- **DO NOT** PLACE ITEMS WITH A STRING, CORD, OR RIBBON AROUND A CHILD'S NECK, SUCH AS HOOD STRINGS OR PACIFIER CORDS.
- **DO NOT** SUSPEND STRINGS OVER A TODDLER BED FOR ANY REASON.
- WHEN STORING TODDLER BED USE CAUTION AS EXTREME CHANGE IN TEMPERATURE OR HUMIDITY CAN COMPROMISE THE TODDLER BED MAKING IT EXTREMELY DANGEROUS TO YOUR CHILD. STORE THE TODDLER BED IN A CLEAN DRY PLACE.
- USE CAUTION WHEN A VAPORIZER OR HUMIDIFIER IS IN USE. ALWAYS AIM VAPOR AWAY FROM THE TODDLER BED AS WELL AS ANY OTHER WOODEN FURNITURE. PROLONGED PERIODS OF HUMIDITY IN STORAGE AS WELL AS THE HOME CAN COMPROMISE THE TODDLER BED.
- AVOID USING VAPORIZERS AND HUMIDIFIER FOR PROLONGED PERIODS OF TIME.
- PLEASE DISPOSE ALL PACKAGING AND PLASTIC BAGS.
- PLEASE CLEAN THE TODDLER BED WITH A DRY CLOTH AND USE MILD WOOD POLISH IF REQUIRED.
- **PREVENT BURNS.** KEEP BED AWAY FROM OPEN FIRES AND OTHER HEAT SOURCES.
- CHECK THIS PRODUCT FOR DAMAGED HARDWARE, LOOSE JOINTS, LOOSE BOLTS OR OTHER FASTENERS, MISSING PARTS OR SHARP EDGES BEFORE AND AFTER ASSEMBLY AND FREQUENTLY DURING USE. SECURELY TIGHTEN LOOSE BOLTS AND OTHER FASTENERS. **DO NOT** USE CRIB IF ANY PARTS ARE MISSING, DAMAGED OR BROKEN. CONTACT BABY CACHE, 91 NEW ENGLAND AVENUE, PISCATAWAY, NEW JERSEY 08854; PHONE: 732-339-6077; EMAIL: INFO@BABYCACHE.COM FOR REPLACEMENT PARTS AND INSTRUCTIONAL LITERATURE IF NEEDED. **DO NOT** SUBSTITUTE PARTS.

# **WARNING ENTRAPMENT/STRANGULATION HAZARD**

- INFANTS HAVE DIED IN TODDLER BEDS FROM ENTRAPMENT AND STRANGULATION.
- FAILURE TO FOLLOW THESE WARNINGS AND THE ASSEMBLY INSTRUCTIONS COULD RESULT IN SERIOUS INJURY OR DEATH.
- **NEVER** USE BED WITH CHILDREN UNDER 15 MONTHS.
- **NEVER** PLACE BED NEAR WINDOWS WHERE CORDS FROM BLINDS OR DRAPES MAY STRANGLE A CHILD.

## **WARNING**

### **INFANTS HAVE DIED IN TODDLER BEDS FROM ENTRAPMENT.**

- OPENINGS IN AND BETWEEN BED PARTS CAN ENTRAP HEAD AND NECK OF A SMALL CHILD.
- **NEVER** USE BED WITH CHILDREN YOUNGER THAN 15 MONTHS.
- **ONLY** USE FULL-SIZE CRIB MATTRESS OF THE RECOMMENDED SIZE.
- **ALWAYS** FOLLOW ASSEMBLY INSTRUCTIONS.

## **WARNING**

### **STRANGULATION HAZARD**

- **NEVER** PLACE BED NEAR WINDOWS WHERE CORDS FROM BLINDS OR DRAPES MAY STRANGLE A CHILD.
- **NEVER** SUSPEND STRINGS OVER BED.
- **NEVER** PLACE ITEMS WITH A STRING, CORD, OR RIBBON, SUCH AS HOOD STRINGS OR PACIFIER CORDS, AROUND A CHILD'S NECK. THESE ITEMS MAY CATCH ON BED PARTS.