

ASSEMBLY INSTRUCTIONS HUTCH

HARDWARE

Screw 3/4"(20mm.) (2 pcs)
(Attached)



Screw Driver (Not Included)

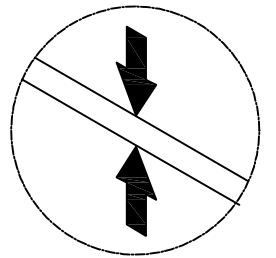
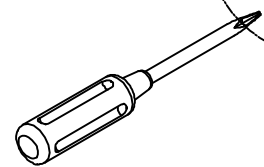
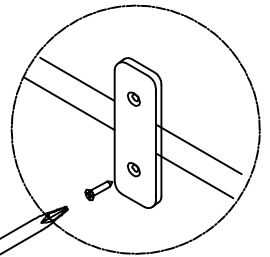
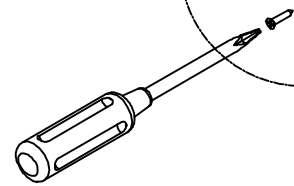
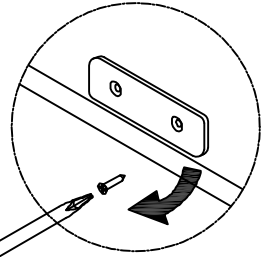
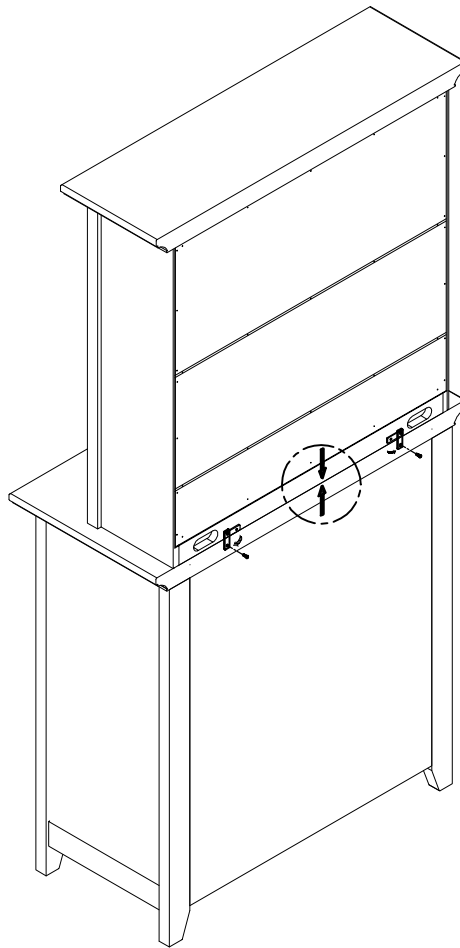
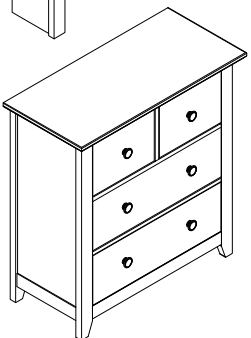
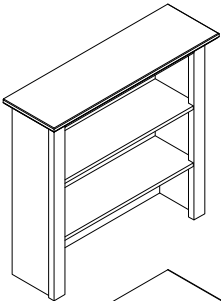
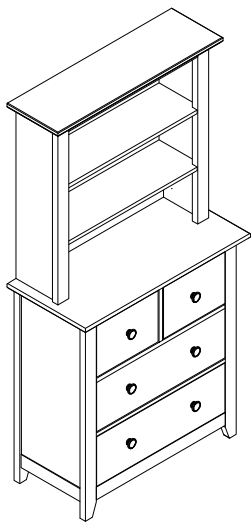
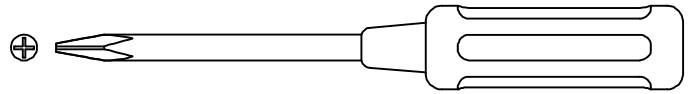

B. Metal plate already attached at HUTCH behind.
Pull out 1 screw at each metal plate,
take around to bottom side, attached again
screw & back plate to DRESSER.

RED ARROW STICKER
(ALREADY ATTACHED)

NOTE : YOU CAN APPLY YOUR HUTCH WITH
"COMBO" OR "DRESSER" OR " CHEST DRAWERS"

A. Put the hutch to the top of casegoods
(example : dresser) in back side.



INSTRUCTIONS D'ASSEMBLAGE

CRÉDENCE

MATÉRIEL

Vis De 3/4" (20 mm) (2 pièces)
(Attachés)



Tour nevis (Non Inclus)

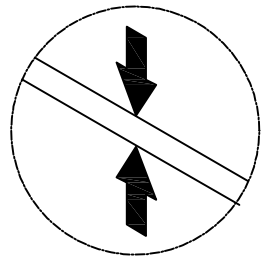
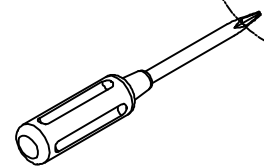
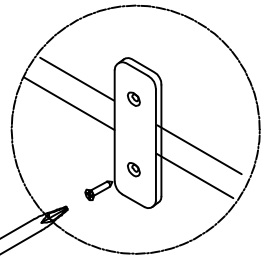
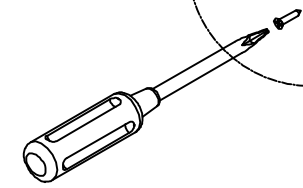
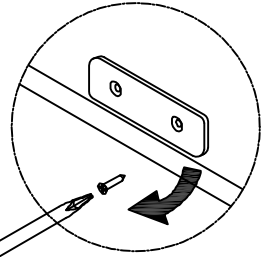
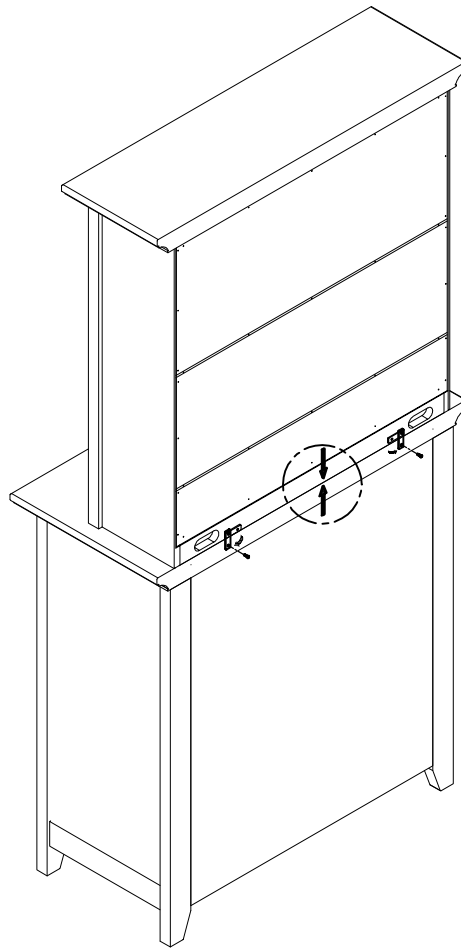
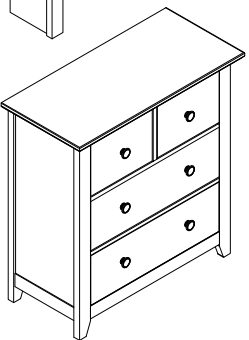
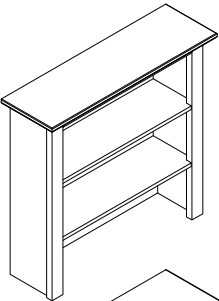
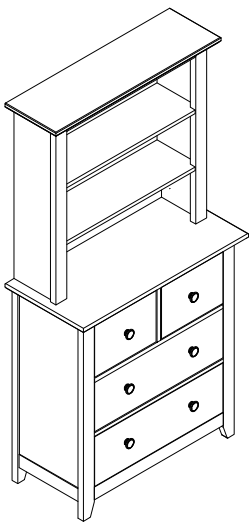
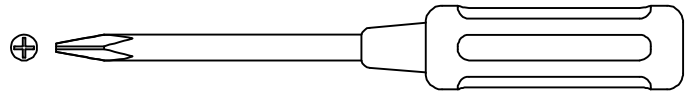

B. Plaque de métal déjà fixée au clavier derrière.
Retirer une vis à chaque plaque de métal,
prendre environ bas sur le côté, joint à nouveau
la vis et la plaque arrière à la buffet.

VIGNETTE FLÈCHE ROUGE
(DÉJA FIXÉE)

NOTE : VOUS POUVEZ APPLIQUER VOTRE
CRÉDENCE AVEC "COMBO" ou "DRESSER"
ou "TIROIR DE COMMUNE"

A. Mettre la cage au début de marchandises
cas (par exemple : buffet) en arrière.

