

# ASSEMBLY INSTRUCTIONS HUTCH

## HARDWARE

Screw 3/4"(20mm.) (2pcs)  
( Attached )

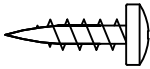

Screw Driver ( Not Included )

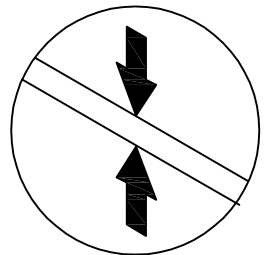
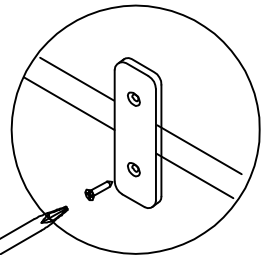
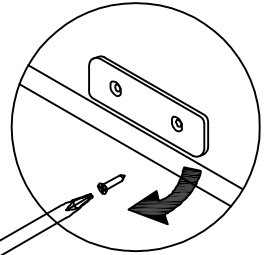
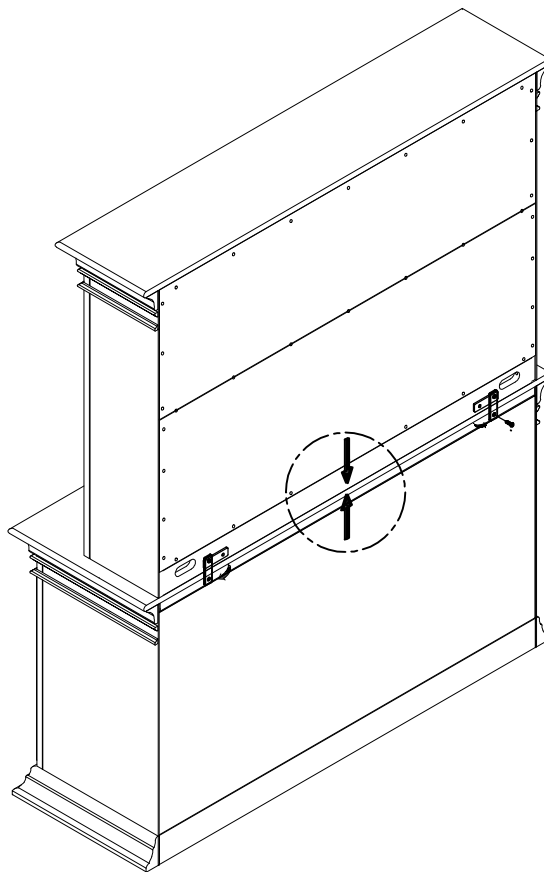
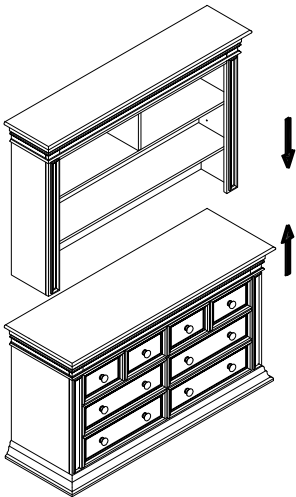
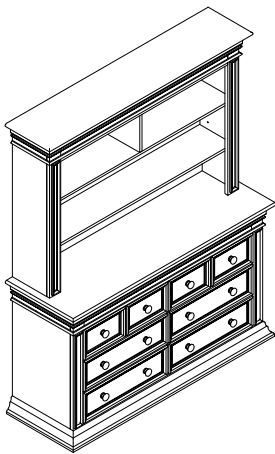
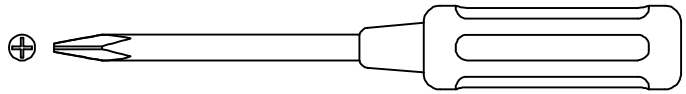

B. Metal plate already attached at HUTCH behind.  
Pull out 1 screw at each metal plate,  
take around to bottom side, attached again  
screw & back plate to DRESSER.

RED ARROW STICKER  
( ALREADY ATTACHED )

NOTE : YOU CAN APPLY YOUR HUTCH WITH  
"COMBO" OR "DRESSER"

A. Put the hutch to the top of casegoods  
( example : dresser ) in back side.



# INSTRUCTIONS D'ASSEMBLAGE

## CRÉDENCE

### MATÉRIEL

Vis De 3/4" (20 mm) ( 2 pièces )  
( Attachès )



Tour nevis ( Non Inclus )

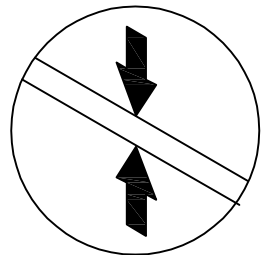
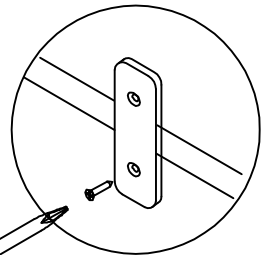
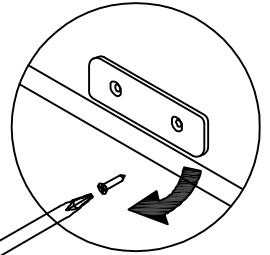
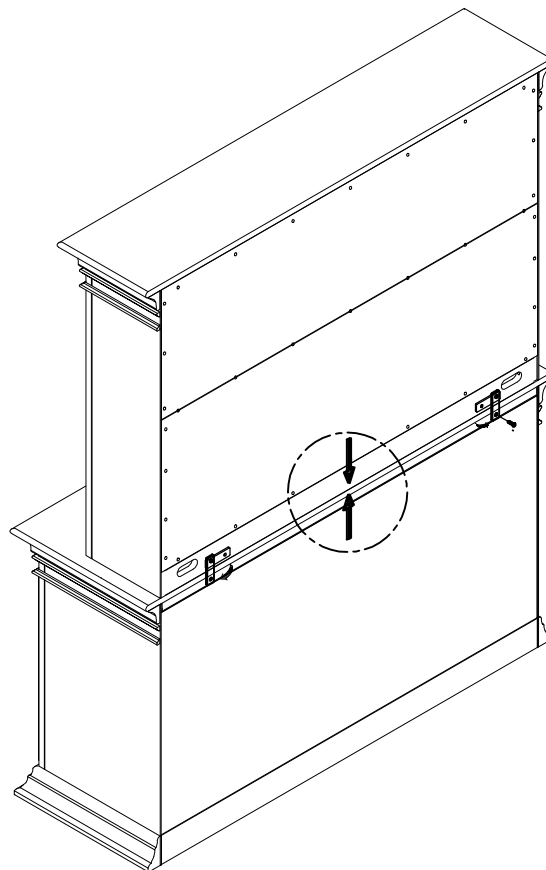
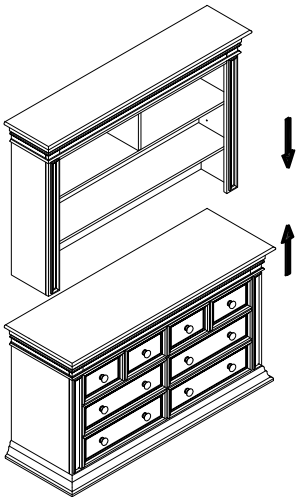
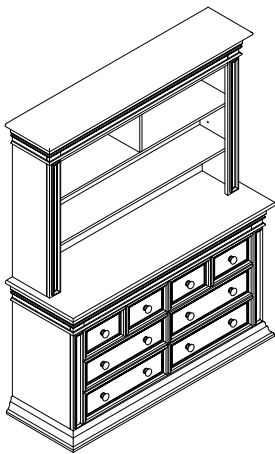
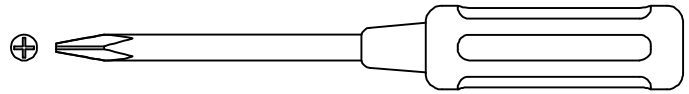

B. Plaque de métal déjà fixée au clavier derrière.  
Retirer une vis à chaque plaque de métal,  
prendre environ bas sur le côté, joint à nouveau  
la vis et la plaque arrière à la buffet.

VIGNETTE FLÈCHE ROUGE  
( DÉJA FIXÉE )

NOTE : VOUS POUVEZ APPLIQUER VOTRE  
CRÉDENCE AVEC "COMBO" ou "DRESSER".

A. Mettre la cage au début de marchandises  
cas ( par exemple : buffet ) en arrière.

