

ASSEMBLY INSTRUCTIONS

Conversion Kit

GLENDALE

Model # 23570

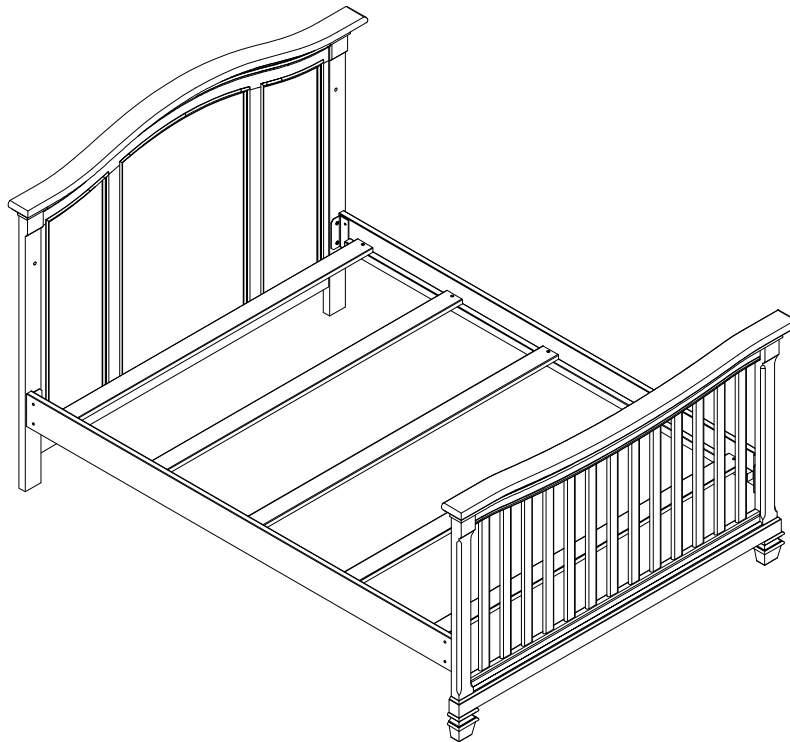

"THE PRODUCT IMAGES SHOWN ARE FOR ILLUSTRATION PURPOSES ONLY AND MAY NOT BE AN EXACT REPRESENTATION OF THE PRODUCT."



WARNING

A mattress foundation must be used with these bed rails.

Carefully remove and lay out all parts. Familiarize yourself with all exhibits and diagrams to facilitate the assembly of your crib

TOOLS REQUIRED :

Allenkey (supplied)

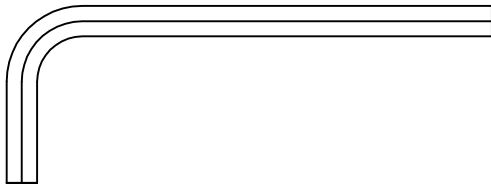

Screw Driver (Unsupplied)

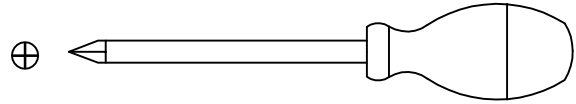

PART ENCLOSED IN CARTON

A. Rails (2 pcs)



B. Slat (5 pcs)

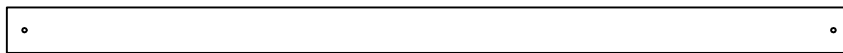

HARDWARE

C. Allenbolt 1" (25 mm) (4 pcs)



L. Nut 3/4" (20 mm) (6 pcs)

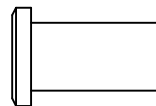

D. Allenbolt 3/4" (20 mm) (6 pcs)

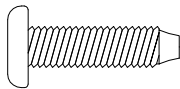

W. Spring Washer (8 pcs)

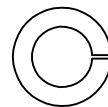

G. Screw 1 1/4" (30 mm) (10 pcs)

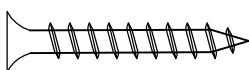

N. Allenkey (2 pcs) (length may vary)



Make sure the bolts are tightly locked against the washers during assembly.
 (Please add an extra 1/2 revolution to all the bolts when using spring washer after tightening)

STEP 1 " ASSEMBLY OF HEAD BOARD "

THIS STEP REQUIRES :

Headboard (1 pc)

A. Rails (2 pcs)

N. Allenkey (2 pcs)

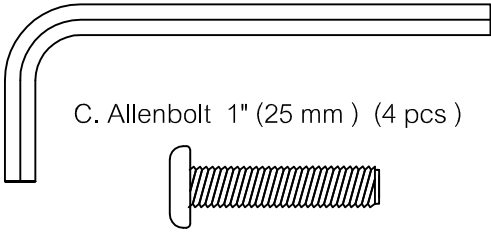

W. Spring Washer (4 pcs)

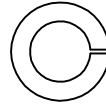

L. Nut 3/4" (20 mm) (4 pcs)

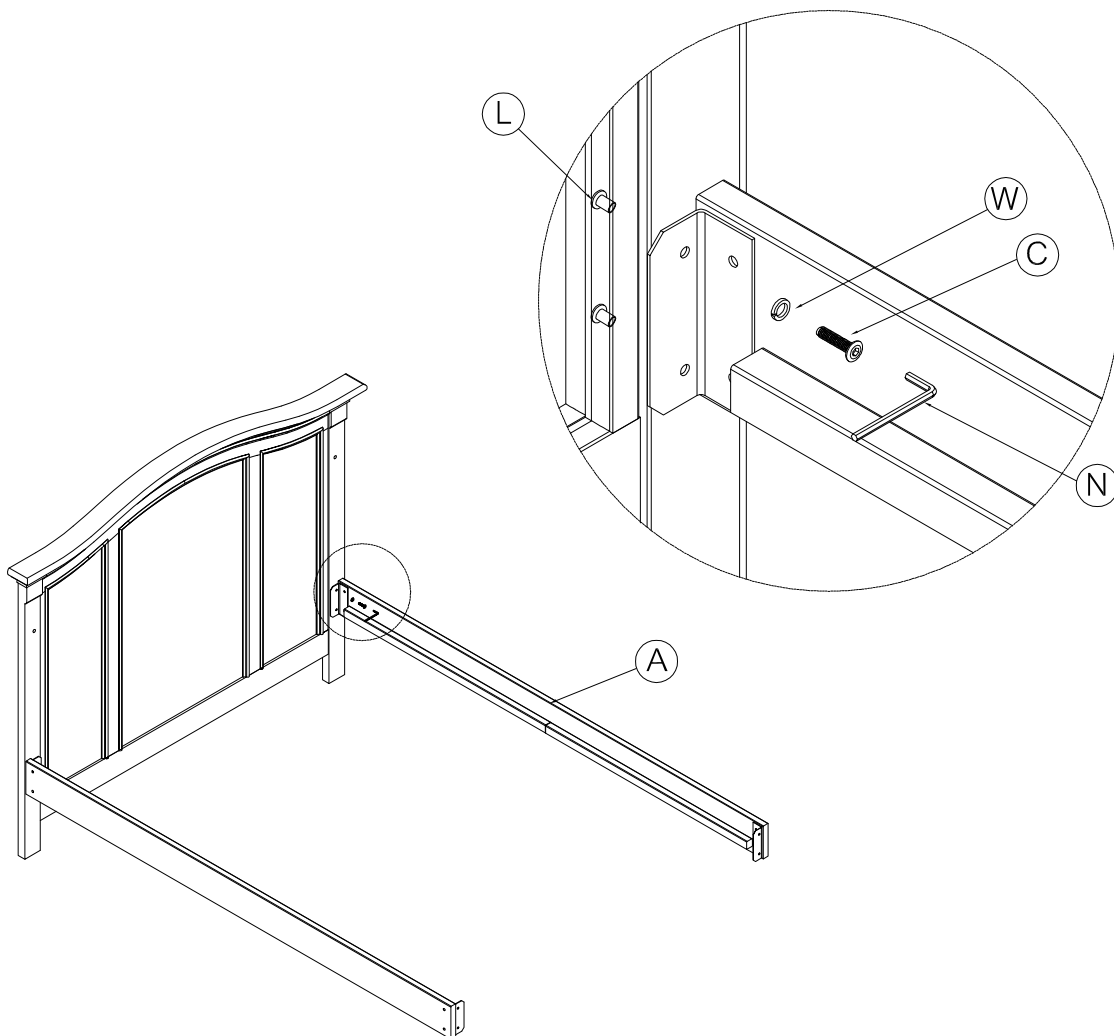
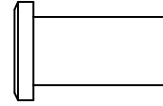

- Insert Allenbolt 1" (25 mm) (C) with spring washer (W) through the metal bracket holes in the end of side rail through the top & bottom holes in headboard and connect with nut 3/4" (20 mm) (L).
Hand tighten only

STEP 2 " ASSEMBLY OF FOOTBOARD "

THIS STEP REQUIRES :

Footboard (1 pc)

N. Allenkey (2 pcs)

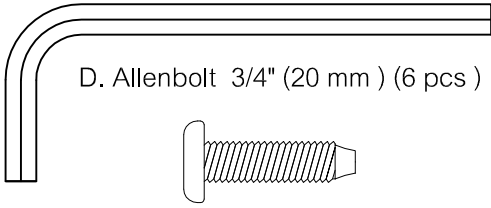

D. Allenbolt 3/4" (20 mm) (6 pcs)

L. Nut 3/4" (20 mm) (2 pcs)

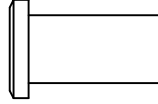

W. Spring Washer (4 pcs)

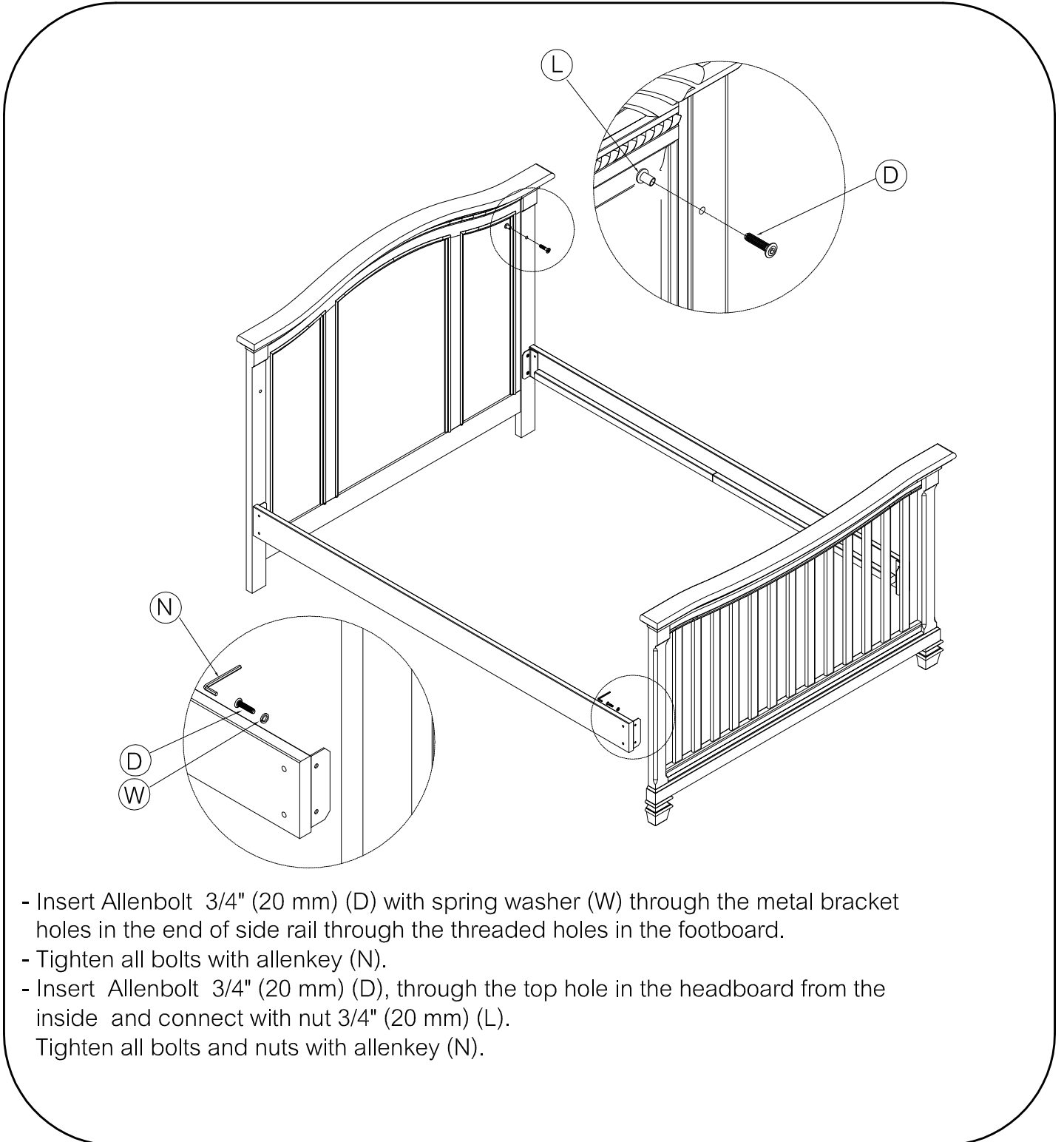

- Insert Allenbolt 3/4" (20 mm) (D) with spring washer (W) through the metal bracket holes in the end of side rail through the threaded holes in the footboard.
- Tighten all bolts with allenkey (N).
- Insert Allenbolt 3/4" (20 mm) (D), through the top hole in the headboard from the inside and connect with nut 3/4" (20 mm) (L).
Tighten all bolts and nuts with allenkey (N).

STEP 3 " ASSEMBLY OF SLATS "

THIS STEP REQUIRES :

B. Slats (5 pcs)

G. Screw 1 1/4" (30 mm) (10 pcs)

Screw Driver
(Unsupplied)

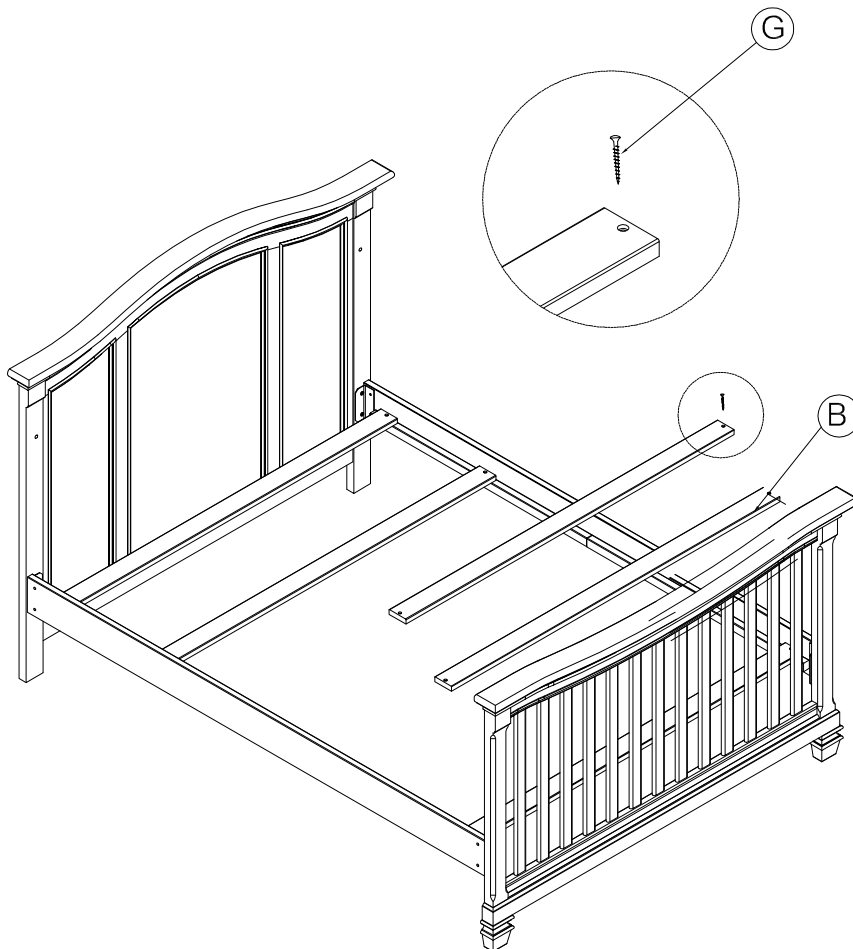
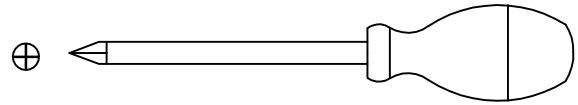
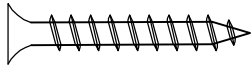

- Install 5 pcs of slats (B) to the 2 pcs of side rail above the pre drilling holes.
- Insert 10 pcs of screw 1 1/4" (30 mm) (G) screws into the slats holes through side rail pre drilling holes. Hand tighten only
- After all 10 pcs of screw inserted, fasten with screw driver.