

ASSEMBLY INSTRUCTIONS HUTCH

HARDWARE

Screw 3/4"(20mm.) (2pcs)
(Attached)

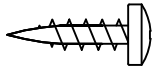

Screw Driver (Not Included)

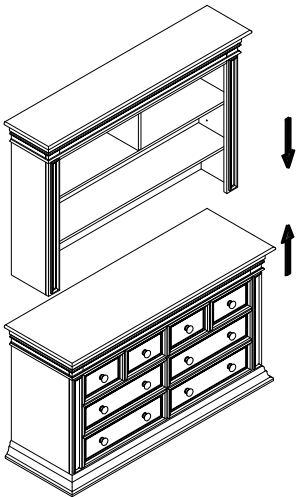
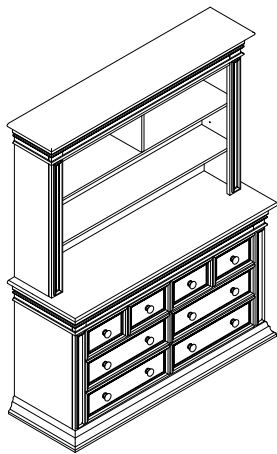
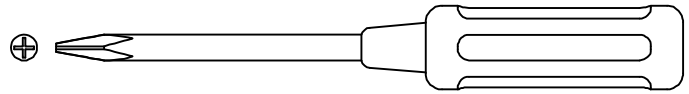

A. Put the hutch to the top of case good (example : dresser) in back side.

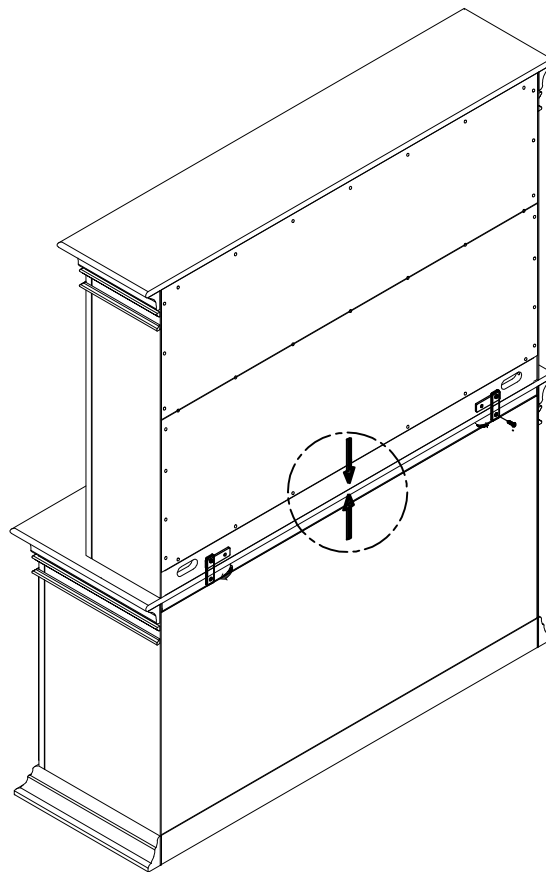

B. Metal plate already attached at HUTCH behind. Pull out 1 screw at each metal plate, take around to bottom side, attached again screw & back plate to DRESSER.

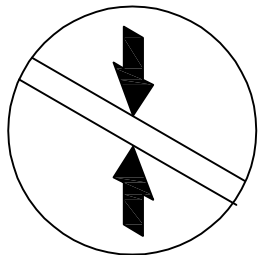
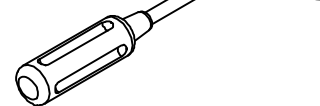
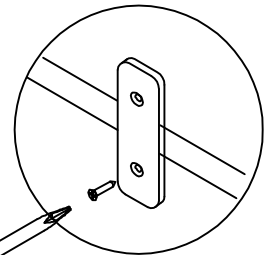
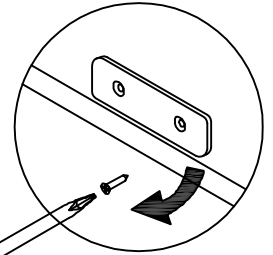

RED ARROW STICKER
(ALREADY ATTACHED)



NOTE : YOU CAN APPLY YOUR HUTCH WITH "COMBO"
OR "DRESSER.

"THE PRODUCT IMAGES SHOWN ARE FOR ILLUSTRATION PURPOSES ONLY AND MAY NOT BE AN EXACT REPRESENTATION OF THE PRODUCT."

INSTRUCTIONS D'ASSEMBLAGE

CRÉDENCE

MATÉRIEL

Vis De 3/4" (20 mm) (2 pièces)
(Attachés)



Tour nevis (Non Inclus)

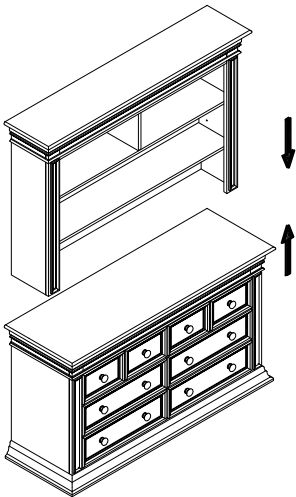
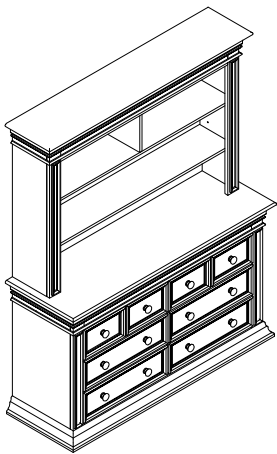
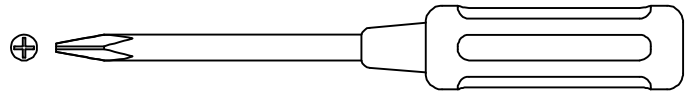

A. Mettre la cage au début de marchandises cas (par exemple : buffet) en arrière.

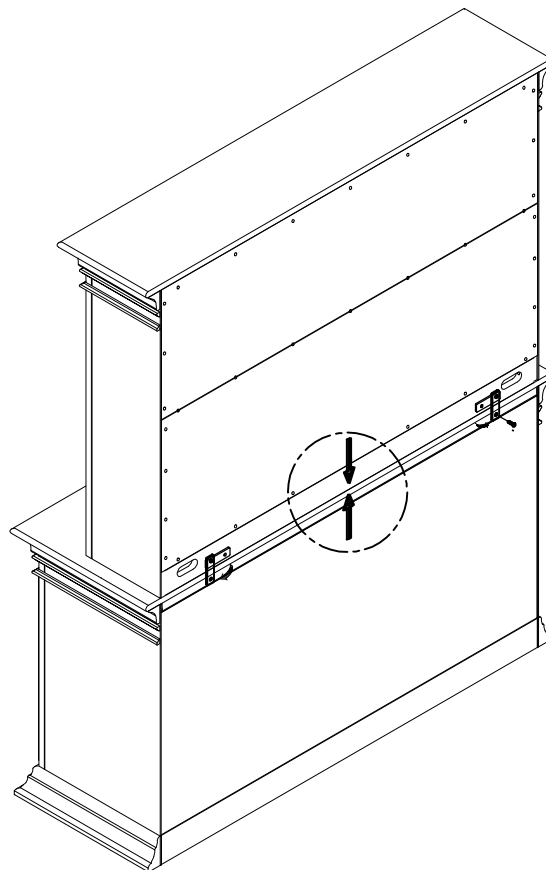

B. Plaque de métal déjà fixée au clapier derrière.
Retirer une vis à chaque plaque de métal,
prendre environ bas sur le côté, joint à nouveau
la vis et la plaque arrière à la buffet.

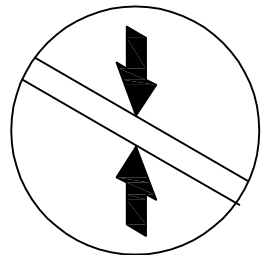
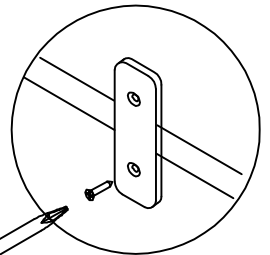
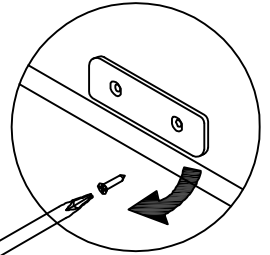

VIGNETTE FLÈCHE ROUGE
(DÉJA FIXÉE)



NOTE : VOUS POUVEZ APPLIQUER VOTRE CRÉDENCE
AVEC "COMBO" ou "DRESSER".

**"LES IMAGES DU PRODUIT PRÉSENTÉES SONT UNIQUEMENT À TITRE
D'ILLUSTRATION ET PEUVENT NE PAS ÊTRE UNE REPRÉSENTATION
EXACTE DU PRODUIT. "**